

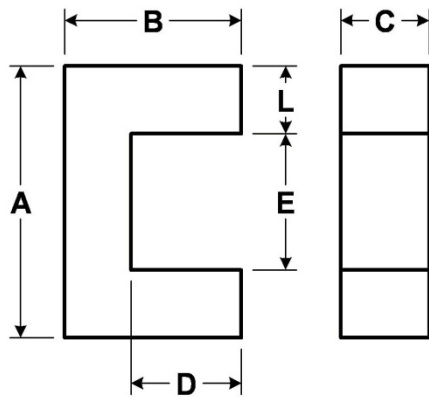

00K8038U026

110 Delta Drive
 Pittsburgh, PA 15238
 Phone: 412/696-1333
 Fax: 412/696-0333
 Email:magnetics@spang.com



Permeability (μ)	A_L (nH/T ²)
26	97 ± 8%

DIMENSIONS (mm)		±
A	80.01	0.89
B	38.1	0.64
C	23.04	0.38
D (min)	22.43	--
E (min)	48.26	--
L (nom)	15.37	--

Markings		
XXXXXX	00K8038U026	N/A
Lot Number	Part Number	Inductance Grade

Physical Characteristics				
A_e (mm ²) Cross Section	L_e (mm) Path Length	V_e (mm ³) Volume	Weight (grams)	Box Quantity (pieces)
354	237	83,9898	225	63

Available Hardware

