



Powder Core Shapes

TECHNICAL BULLETIN

Available in various sizes, Magnetics powder core shapes compare favorably with gapped ferrites, powdered iron and silicon steel cores. In addition, for very large core requirements, these large shapes can be configured and bonded into a number of custom designs. Shapes include E core, U core, EQ core, EER core, LP core, Cylinder, Block, and Round Block.

Kool μ [®] Shapes

Ideal for high current inductors, Kool μ geometries offer all the advantages of Kool μ material: low core loss, excellent performance over temperature, near zero magnetostriction and soft saturation.

Available in: Block, Cylinder, E, EER, EQ, LP, Round Block, U

Kool μ [®] MAX Shapes

Kool μ MAX provides 50% better DC bias than standard Kool μ and is suitable for high efficiency, high power inductors.

Available in: Block, Cylinder, E, EER, EQ, LP, Round Block, U

Kool μ [®] Hf Shapes

Kool μ Hf exhibits 35% lower losses compared to Kool μ and is a cost-effective solution for minimizing power losses in high frequency power supplies.

Available in: Block, Cylinder, E, Round Block, U

XFLUX[®] Shapes

XFLux is ideal for low and medium frequency inductors and chokes. XFLux is characterized by its high saturation (1.6 Tesla), which is advantageous in applications where inductance under load is critical.

Available in: Block, Cylinder, E, EER, EQ, LP, Round Block, U

High DC Bias XFLux[®] Shapes Available in: Block, Cylinder, E, Round Block, U

High Flux Shapes

High Flux is characterized by its high saturation flux density (15,000 gauss) and relatively low losses. High Flux shapes may be used in applications involving high power, high DC bias, or high AC bias at high power frequencies.

Available in: Block, Cylinder, E, EER, EQ, LP, Round Block, U

Edge[®] Shapes

Edge displays both excellent DC bias capability and low losses - approximately 30% improvement in DC bias and 40% lower losses compared to High Flux. Choose Edge for highest efficiency.

Available in: Block, Cylinder, E, EER, EQ, LP, Round Block

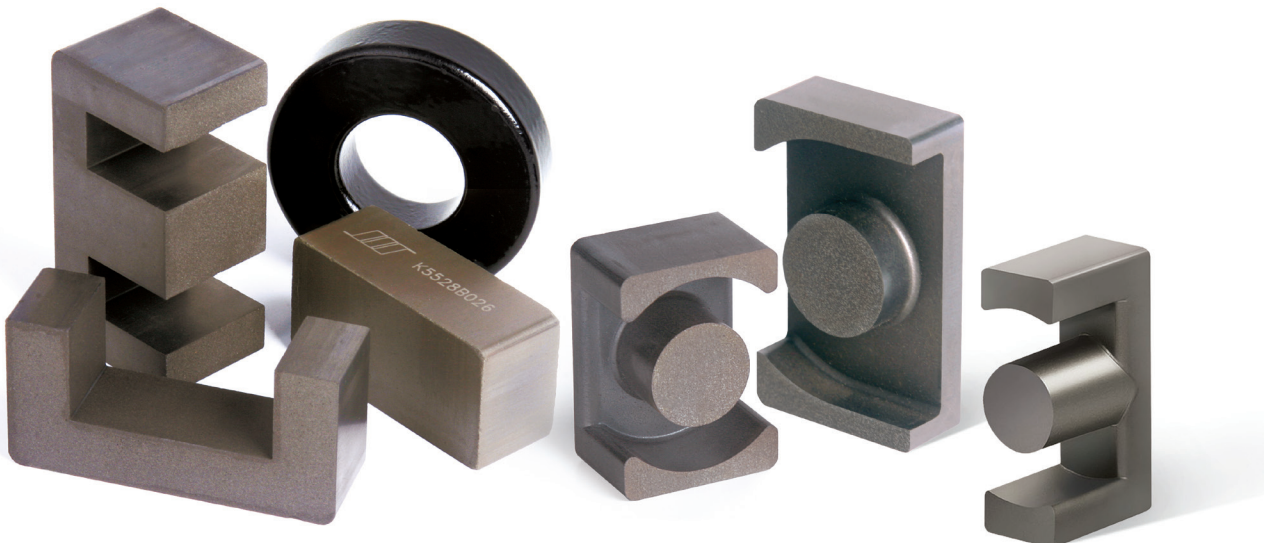

Dimensions

E CORES		A	B	C	D(min)	E(min)	F	L(nom)	M(min)
1808E <i>EI-187</i>	mm	19.30	8.10	4.78	5.53	13.90	4.78	2.39	4.64
2510E <i>E-2425</i>	mm	25.40	9.53	6.35	6.22	18.70	6.35	3.18	6.24
3007E <i>DIN 30/7</i>	mm	30.10	15.00	7.06	9.55	19.80	6.96	5.11	6.32
3515E <i>EI-375</i>	mm	34.54	14.20	9.35	9.60	25.20	9.32	4.45	7.87
4017E <i>EE 42/11</i>	mm	42.85	21.10	10.80	14.90	30.30	11.90	5.94	9.27
4020E <i>DIN 42/15</i>	mm	42.85	21.10	15.40	14.90	30.35	11.90	5.94	9.27
4022E <i>DIN 42/20</i>	mm	42.85	21.10	20.00	14.90	30.35	11.90	5.94	9.27
4317E <i>EI-21</i>	mm	40.87	16.59	12.50	10.30	28.32	12.50	6.05	7.87
5528E <i>DIN 55/21</i>	mm	54.86	27.56	20.60	18.50	37.49	16.80	8.38	10.20
5530E <i>DIN 55/25</i>	mm	54.86	27.56	24.60	18.50	37.49	16.80	8.38	10.20
6527E <i>Metric E65</i>	mm	65.15	32.51	27.00	22.10	44.19	19.70	10.00	12.00
7228E <i>F11</i>	mm	72.39	27.94	19.10	17.70	52.62	19.10	9.53	16.80
8020E <i>Metric E80</i>	mm	80.01	38.10	19.80	28.01	59.28	19.80	9.91	19.80
8024E	mm	80.01	24.05	29.72	14.02	59.28	19.80	9.91	19.80
8044E	mm	80.01	44.58	19.80	34.36	59.28	19.80	9.91	19.80
114LE	mm	114.30	46.18	34.93	28.60	79.50	35.10	17.20	22.10
130LE	mm	130.30	32.51	53.85	22.10	108.40	20.00	10.00	44.22
160LE	mm	160.00	38.10	39.62	28.14	138.20	19.80	9.91	59.28

U CORES		A	B	C	D	E	L
3112U	mm	31.24	11.20	12.10	2.54	14.20	8.26
4110U	mm	40.64	11.20	9.53	2.54	23.60	8.38
4111U	mm	40.64	11.20	12.10	2.54	23.60	8.38
4119U	mm	40.64	11.20	19.10	2.54	23.60	8.38
5527U	mm	54.86	27.56	16.30	16.70	33.78	10.50
5529U	mm	54.86	27.56	23.20	16.50	33.02	10.50
6527U	mm	65.15	32.51	27.00	22.10	44.22	10.00
6533U	mm	65.15	32.51	20.00	19.60	39.24	12.50
7236U	mm	72.39	35.56	20.90	21.30	43.68	13.90
8020U	mm	80.01	38.10	19.80	28.14	59.28	9.91
8038U	mm	80.01	38.10	23.00	22.40	49.27	15.40

BLOCKS		A	B	C
4741B	mm	47.50	41.00	27.51
5030B	mm	50.50	30.30	15.00
5528B	mm	54.86	27.56	20.60
6020B	mm	60.50	20.30	20.00
6030B	mm	60.00	30.00	15.00
6131B	mm	60.50	30.30	20.00
7020B	mm	70.50	20.30	20.00
7030B	mm	70.50	30.30	20.00
8030B	mm	80.49	30.30	20.00
9541B	mm	95.00	41.00	27.51

ROUND BLOCKS		A	B	C	RADIUS
3515R	mm	35.30	15.20	25.00	7.50
6524R	mm	64.50	24.20	18.80	12.00
7543R	mm	75.00	43.00	15.50	21.50
8030R	mm	80.50	30.20	23.50	15.00
8430R	mm	84.00	30.00	23.00	15.00
9040R	mm	90.00	40.00	15.00	20.00

Dimension Drawings

Magnetic Data

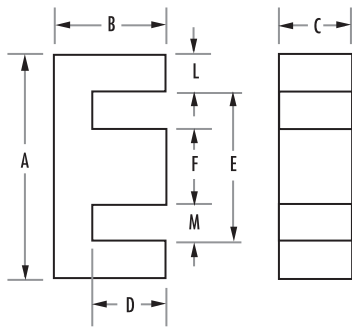

E CORES

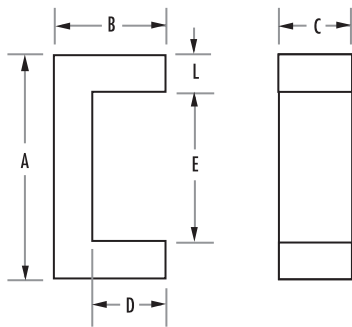

U CORES

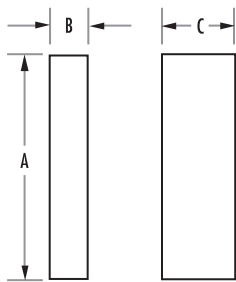

BLOCKS

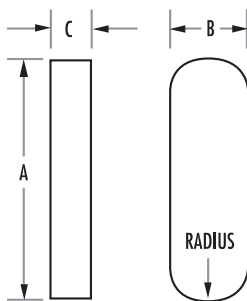

ROUND BLOCKS

E CORES	$A_L \text{ nH/T}^2 \pm 8\%$				Path Length l_e (mm)	Cross Section A_e (mm ²)	Volume V_e (mm ³)
	26 μ	40 μ	60 μ	90 μ			
1808E	26	35	48	69	40.1	22.8	914
2510E	39	52	70	100	48.5	38.5	1,870
3007E	33	46	71	92	65.6	60.1	3,940
3515E	56	75	102	146	69.4	84.0	5,830
4017E	56	76	105	151	98.4	128	12,600
4020E	80	108	150	217	98.4	183	18,000
4022E	104	140	194	281	98.4	237	23,300
4317E	88	119	163	234	77.5	152	11,800
5528E	116	157	219	322	123	350	43,100
5530E	138	187	261	382	123	417	51,300
6527E	162	230	300	-	147	540	79,400
7228E	130	173	235	-	137	368	50,400
8020E	103	145	190	-	185	389	72,000
8024E	200	275	370	-	131.4	600	78,840
8044E	91	113	170	-	208	389	80,900
114LE	235	335	445	-	215	1,220	262,000
130LE	254	-	-	-	219	1,080	237,000
160LE	180	-	-	-	273	778	212,000
U CORES	$A_L \text{ nH/T}^2 \pm 8\%$				Path Length l_e (mm)	Cross Section A_e (mm ²)	Volume V_e (mm ³)
	26 μ	40 μ	60 μ	90 μ			
3112U	61	92	111	179	65.6	101	6,630
4110U	42	56	78	109	85.2	80	6,820
4111U	52	72	95	138	85.2	101	8,600
4119U	79	110	151	218	85.2	159	13,600
5527U	67	94	120	-	168	172	28,900
5529U	85	121	160	-	168	244	41,000
6527U	89	111	165	-	219	270	59,100
6533U	82	109	143	-	199	250	49,800
7236U	87	114	149	-	219	290	63,500
8020U	64	77	95	-	273	195	53,200
8038U	97	124	179	-	237	354	83,900
BLOCKS	$A_L \text{ nH/T}^2 \pm 8\%$		Path Length l_e (mm)		Cross Section A_e (mm ²)		Volume V_e (mm ³)
4741B	**	**	**	**	**	**	53,600
5030B	**	**	**	**	**	**	23,000
5528B	**	**	**	**	**	**	31,200
6020B	**	**	**	**	**	**	56,550
6030B	**	**	**	**	**	**	27,000
6131B	**	**	**	**	**	**	36,700
7030B	**	**	**	**	**	**	42,800
8030B	**	**	**	**	**	**	48,800
9541B	**	**	**	**	**	**	107,200
ROUND BLOCKS	$A_L \text{ nH/T}^2 \pm 8\%$		Path Length l_e (mm)		Cross Section A_e (mm ²)		Volume V_e (mm ³)
3515R	**	**	**	**	380	**	18,000
6524R	**	**	**	**	877	**	27,000
7543R	**	**	**	**	645	**	42,420
8030R	**	**	**	**	710	**	52,450
8430R	**	**	**	**	690	**	53,520
9040R	**	**	**	**	600	**	48,850

Dimensions

CYLINDERS		A	C
011020C	mm	11.40	20.00
015010C	mm	15.00	10.50
015012C	mm	15.00	12.00
015018C	mm	15.00	18.00
015020C	mm	15.00	20.00
015022C	mm	15.00	22.00
020010C	mm	20.32	10.00
021018C	mm	21.00	17.50
021020C	mm	21.00	20.00
024020C	mm	24.00	20.00
024025C	mm	24.00	25.00
028020C	mm	28.00	20.00
028022C	mm	28.00	21.50

CYLINDERS		A	C
030018C	mm	30.00	18.00
030020C	mm	30.00	20.00
030027C	mm	30.00	27.50
033020C	mm	33.00	20.00
033022C	mm	33.00	21.50
042020C	mm	42.00	20.00
042030C	mm	42.00	30.00
047018C	mm	46.74	18.00
047020C	mm	46.74	20.00
051020C	mm	50.55	20.00
057015C	mm	57.15	15.00
074020C	mm	74.10	20.00
074025C	mm	74.00	25.00

EQ CORES		A	B	C	D	E	F
EQ_2014E***L050	mm	20.00	5.00	14.00	2.60	18.00	8.79
EQ_2014E***L061	mm	20.00	6.10	14.00	3.70	18.00	8.79
EQ_2619E***L070	mm	26.50	7.00	19.00	3.70	22.60	12.00
EQ_2619E***L088	mm	26.50	8.80	19.00	5.50	22.60	12.00
EQ_2619E***L101	mm	26.50	10.10	19.00	6.80	22.60	12.00
EQ_2619E***L124	mm	26.50	12.40	19.00	9.10	22.60	12.00
EQ_3222E***L101	mm	32.00	10.10	22.00	6.40	27.60	13.50
EQ_3222E***L152	mm	32.00	15.20	22.00	11.50	27.60	13.50
EQ_3222E***L180	mm	32.00	18.00	22.00	14.30	27.60	13.50
EQ_3626E***L100	mm	36.00	10.00	26.00	6.00	32.00	14.40
EQ_3626E***L110	mm	36.00	11.00	26.00	7.00	32.00	14.40
EQ_3626E***L174	mm	36.00	17.40	26.00	13.40	32.00	14.40
EQ_4128E***L120	mm	41.50	12.00	28.00	7.50	36.50	14.90
EQ_4128E***L199	mm	41.50	19.90	28.00	15.40	36.50	14.90
EQ_5032E***L200	mm	50.00	20.00	32.00	14.50	44.00	20.00
EQ_5032E***L250	mm	50.00	25.00	32.00	19.50	44.00	20.00

LP CORES		A	B	C	D	E	F
LP_2314E***L087	mm	23.39	8.71	14.00	6.20	19.41	9.19
LP_2518E***L099	mm	25.00	9.90	18.00	6.90	21.00	11.00
LP_3020E***L118	mm	30.00	11.80	20.00	8.50	25.60	12.00
LP_3222E***L152	mm	32.00	15.20	22.00	11.50	27.00	13.50
LP_3624E***L144	mm	36.20	14.40	24.00	10.40	30.40	15.00
LP_4225E***L107	mm	42.00	10.70	25.00	6.30	35.20	16.20
LP_4225E***L123	mm	42.00	12.30	25.00	7.90	35.20	16.20
LP_4225E***L158	mm	42.00	15.80	25.00	11.40	35.20	16.20

EER CORES		A	B	C	D	E	F
ER_2507E***L110	mm	25.50	11.00	7.50	7.90	19.80	7.50
ER_4013E***L224	mm	40.00	22.40	13.30	15.40	29.00	13.30

Dimension Drawings

Magnetic Data

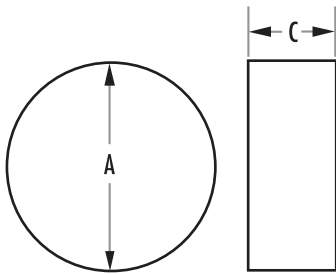

CYLINDERS

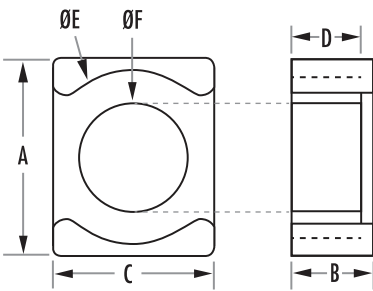

EQ CORES

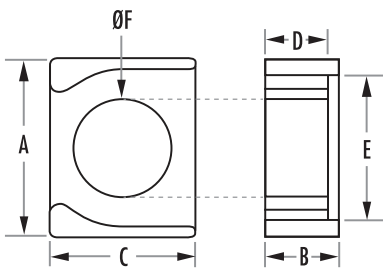

LP CORES

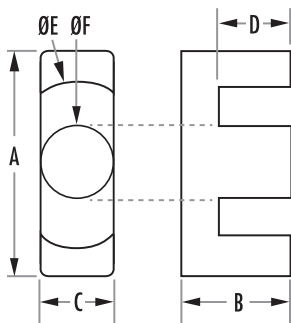

EER CORES

CYLINDERS	Cross Section A_e (mm ²)	Volume V_e (mm ³)	CYLINDERS	Cross Section A_e (mm ²)	Volume V_e (mm ³)
011020C	102.1	2,041	030018C	706.9	12,723
015010C	176.7	1,856	030020C	706.9	14,137
015012C	176.7	2,121	030027C	706.9	19,439
015018C	176.7	3,181	033020C	855.3	17,106
015020C	176.7	3,534	033022C	855.3	18,389
015022C	176.7	3,888	042020C	1,385.4	27,709
020010C	324.3	3,243	042030C	1,385.4	27,709
021018C	346.4	6,061	047018C	1,715.8	30,884
021020C	346.4	6,927	047020C	1,715.8	34,316
024020C	452.4	9,048	051020C	2,006.9	40,139
024025C	452.4	9,048	057015C	2,565.2	38,478
028020C	615.8	12,315	074020C	4,312.8	86,249
028022C	615.8	13,239	074025C	4,300.8	107,521

EQ CORES	A_L nH/T ² ± 8%				Path Length l_e (mm)	Cross Section A_e (mm ²)	Volume V_e (mm ³)
	26 μ	40 μ	60 μ	75 μ			
EQ_2014E***L050	81	120	167	203	29.3	60.8	1,780
EQ_2014E***L061	67	98	138	166	35.8	60.8	2,180
EQ_2619E***L070	111	164	228	278	42.3	119.8	5,070
EQ_2619E***L088	95	140	195	237	49.5	119.8	5,834
EQ_2619E***L101	86	127	177	215	54.7	119.8	6,550
EQ_2619E***L124	74	108	151	184	63.9	119.8	7,650
EQ_3222E***L101	100	148	207	251	59.5	152.3	9,100
EQ_3222E***L152	75	110	156	187	79.9	152.3	12,168
EQ_3222E***L180	66	97	136	164	91.1	152.3	13,900
EQ_3626E***L100	109	160	223	272	65.1	180.8	11,800
EQ_3626E***L110	102	151	211	256	69.1	180.8	12,500
EQ_3626E***L174	75	110	154	187	94.7	180.8	17,122
EQ_4128E***L120	94	138	193	234	83.6	199.7	16,700
EQ_4128E***L199	68	100	140	163	115.2	199.7	23,000
EQ_5032E***L200	109	160	223	271	113.4	314.1	35,600
EQ_5032E***L250	92	136	190	231	133.4	314.1	41,900

LP CORES	A_L nH/T ² ± 8%				Path Length l_e (mm)	Cross Section A_e (mm ²)	Volume V_e (mm ³)
	26 μ	40 μ	60 μ	75 μ			
LP_2314E***L087	54	79	110	134	49.1	67.0	3,290
LP_2518E***L099	68	100	139	169	55.7	96.0	5,350
LP_3020E***L118	65	96	134	163	68.5	114.0	7,800
LP_3222E***L152	69	101	141	171	82.1	143.0	11,740
LP_3624E***L144	86	127	177	215	80.6	177.0	14,270
LP_4225E***L107	116	171	239	290	69.7	206.0	14,360
LP_4225E***L123	106	156	218	265	76.1	206.0	15,680
LP_4225E***L158	90	132	184	224	90.1	206.0	18,560

75 μ available in XFlux

EER CORES	A_L nH/T ² ± 8%			Path Length l_e (mm)	Cross Section A_e (mm ²)	Volume V_e (mm ³)
	26 μ	40 μ	60 μ			
ER_2507E***L110	34	47	65	57.8	45	2,600
ER_4013E***L224	59	81	111	111.3	149.1	16,600

Materials & DC Bias

The most critical parameter of a switching regulator inductor material is its ability to provide inductance or maintain permeability under DC Bias. The Permeability vs. DC Bias chart (Figure 1) shows the reduction of permeability as a function of DC Bias for Kool M μ toroids. The distributed air gap of powder cores results in a more gradual drop in inductance with increased DC Bias. In most applications, this swinging inductance is desirable since it improves efficiency, decreases the volume needed and accommodates a wide operating range. With a fixed current requirement, the soft inductance versus DC Bias curve also provides added protection against overload conditions.

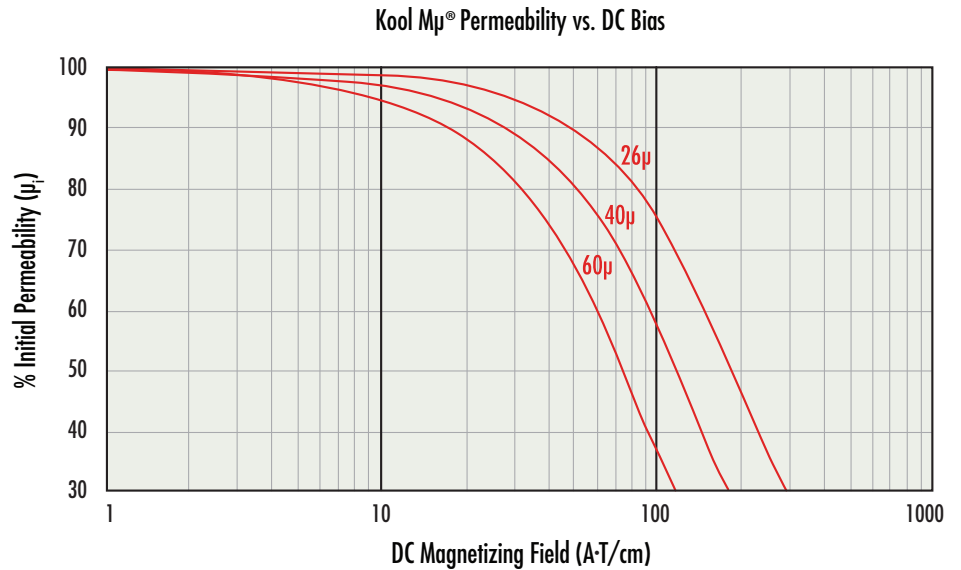

FIGURE 1

Leakage Flux

Leakage Flux occurs when some of the magnetic field is not contained within the core structure. All transformers and inductors have some amount of leakage flux. In an idealized core with no leakage flux, inductance is calculated via the following:

$$L = \frac{.4 \pi \mu N^2 A_e 10^{-6}}{l_e}$$

L = inductance in mH
 μ = core permeability
 N = number of turns

A_e = effective cross section in mm²
 l_e = core magnetic path length in mm

In low permeability materials the effect of leakage flux is that measured inductance is higher than the inductance calculated using the equation shown above. The increase in measured inductance compared to calculated inductance, due to leakage, is strongly affected by the number of turns as well as by the coil design and geometry. These effects can also extend to DC Bias performance and core loss.

Effects on performance under DC Bias can be seen in the sample tests shown below. U-core inductors wound on only one leg show a marked decrease in performance compared to the same cores with windings distributed over 2-legs, which yields performance comparable to E-cores and toroids.

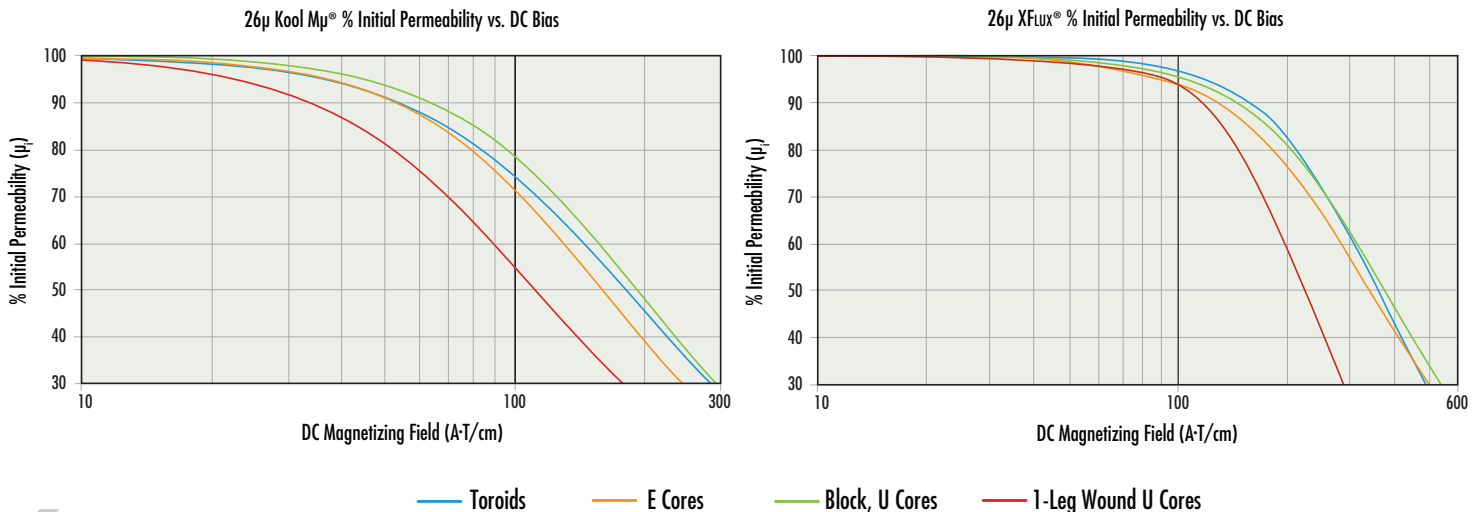

26 μ Kool M μ ® Core Loss Density Comparison, 100 kHz

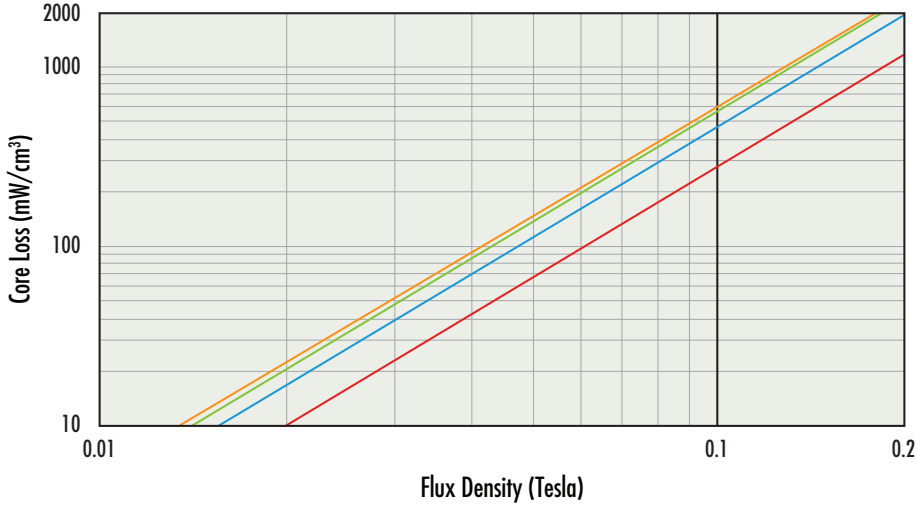

Effects on core loss can also be seen in the sample tests shown left. U-cores wound on only one leg have a noticeable decrease in core loss, followed by the same U-cores wound on two legs, then E-cores, then toroids.

- Toroid test samples
- E-core test samples
- U-core test samples: 2-leg
- U-core test samples: 1-leg

26 μ XFlux® Core Loss Density Comparison, 100 kHz

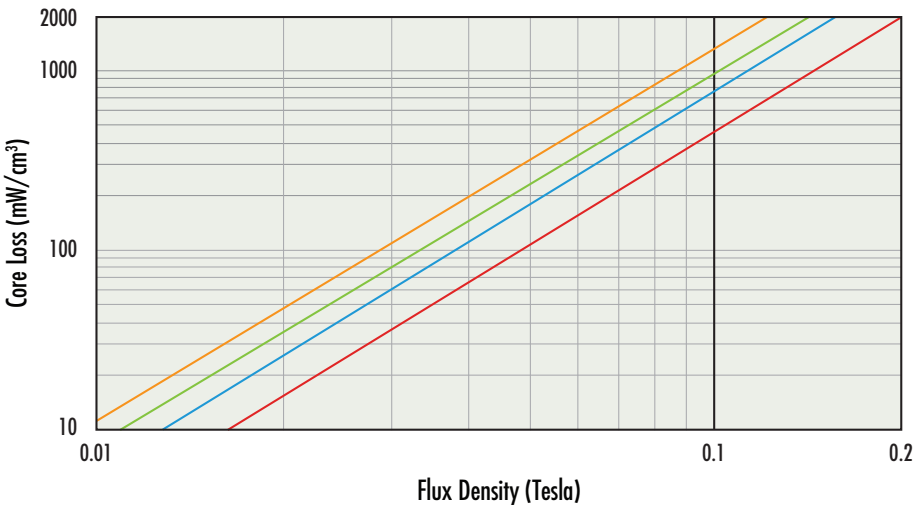

Core dimensions also affect leakage flux – In the case of an E core, a core with a longer winding length will have less leakage than a core with a shorter winding length, and a core with less winding build will have more leakage than a core with more winding build. Magnetics Kool M μ E cores are tested for inductance factor (A_L) with full 100- or 200-turn coils. U-core inductance factors are listed for 1-leg windings.

- Toroid test samples
- E-core test samples
- U-core test samples: 2-leg
- U-core test samples: 1-leg

External Leakage Field

External leakage field must be considered when using an E core, U core, or block assembly as core shape affects the leakage flux. Powder core shapes (E cores, U cores, and blocks), where most of the core surrounds the winding, have a greater external leakage field than the toroidal shape, where the winding surrounds the core.

E cores, U cores, and blocks should not be assembled with metallic brackets since the leakage flux may cause eddy current heating in the brackets. The leakage field must be considered when laying out the circuit board. Components susceptible to stray magnetic field should be spaced away from the core. For more information on this subject, visit Magnetics' website to download the white paper, "Leakage Flux Considerations on Kool M μ E Cores."



Special Designs & Assembly Considerations

Many applications require a custom assembly or even a custom core. The material properties and flexibility of geometries make powder cores ideal for custom assemblies.

Discrete air gaps between powder core blocks are not generally needed because the air gap is inherent in the material. At the same time, extremely smooth mating surfaces (such as are employed with ferrites) are not required because the small incidental gap between blocks does not add appreciable extra gap and does not reduce inductance significantly.

The adhesives used for assembling blocks generally need to be thicker than those commonly used for ferrite assemblies, since powder core surfaces are rougher and more porous. Cores may require a double application of adhesive to ensure a strong bond.

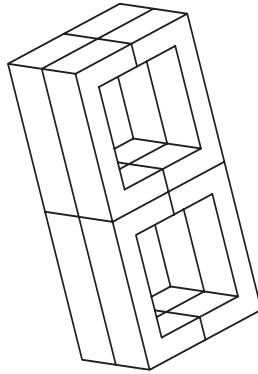

QUANTITY OF 8 6527U CORES
STACKED TO MAKE (1) 130LE SET

$A_L = 254 \pm 8\%$ (26 μ)

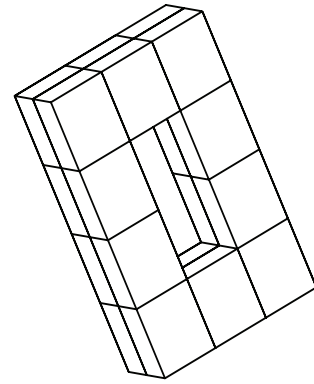

QUANTITY OF 20 4741B BLOCKS
 $A_L = 202 \pm 8\%$ (26 μ)

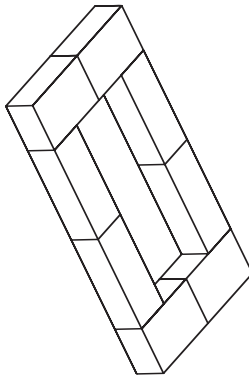

QUANTITY OF 8 6030B BLOCKS

$A_L = 42 \pm 8\%$ (26 μ)

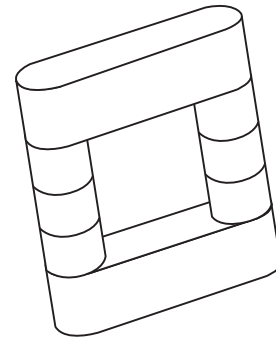

CYLINDER AND ROUNDED BLOCK ASSEMBLY

Contact Magnetics for more information.

Headquarters

110 Delta Drive
P.O. Box 11422
Pittsburgh, PA 15238 • USA

Phone: **1.800.245.3984**
+1.412.963.9363

e-mail:
magnetics@spang.com



Magnetics International

13/F 1-3 Chatham Road South
Tsim Sha Tsui
Kowloon, Hong Kong

Phone: **+852.2731.9700**
+86.139.1147.1417

e-mail:
asiasales@spang.com