



Headquarters

110 Delta Drive
P.O. Box 11422
Pittsburgh, PA 15238 • USA

Phone: **1.800.245.3984**
+1.412.696.1333

e-mail: **magnetics@spang.com**

Magnetics International

13/F 1-3 Chatham Road South
Tsim Sha Tsui
Kowloon, Hong Kong

Phone: **+852.2731.9700**
+86.139.1147.1417

e-mail: **asiasales@spang.com**

www.mag-inc.com

©2021 Magnetics





FERRITE CORES

Toroids • Shapes • Pot Cores

Part Number Index

TOROIDS				E CORES						SHAPES				
TOROID	PG	TOROID	PG	E, I	PG	PLANAR E, I	PG	EC	PG	U, I	PG	Pot		
40200TC	20	44416TC	24	40904EC	28	41425EC	32	43517EC	42	41106UC	38	40704UG	54	
40301TC	20	44419TC	24	41203EC	28	41434EC	32	44119EC	42	41106IC	38	40905UG	54	
40401TC	20	44715TC	24	41205EC	28	41434IC	32	45224EC	42	42220UC	38	41107UG	54	
40402TC	20	44916TC	26	41707EC	28	41805EC	32	47035EC	42	42512UC	38	41109UG	54	
40502TC	20	44920TC	26	41808EC	28	41805IC	32	EER		42515UC	38	41408UG	54	
40503TC	20	44925TC	26	41810EC	28	42107EC	32	42814EC	44	42516IC	38	41811UG	54	
40601TC	20	44932TC	26	42510EC	28	42107IC	32	42817EC	44	42530UC	38	41814UG	54	
40603TC	20	46013TC	26	42513EC	28	42214EC	32	43521EC	44	49316UC	38	42213UG	54	
40705TC	20	46019TC	26	42515EC	28	42214IC	32	44013EC	44	49316IC	38	42438UG	54	
40907TC	20	46113TC	26	42520EC	28	42216EC	32	44216EC	44	49330UC	38	42616UG	54	
41003TC	20	46325TC	26	42526EC	28	42216IC	32	44818EC	44	49332UC	38	42823UG	54	
41005TC	20	46326TC	26	42530EC	28	42217EC	32	44821EC	44	49920UC	38	43019UG	54	
41206TC	20	47313TC	26	43007EC	28	43208EC	32	45418EC	44	49925UC	38	43622UG	54	
41303TC	20	47325TC	26	43009EC	28	43208IC	32	EFD		49925IC	38	44229UG	54	
41304TC	20	47326TC	26	43515EC	28	43618EC	32	41009EC	46	UR		RS-DS	PG	
41305TC	20	48613TC	26	43520EC	28	43618IC	32	41212EC	46	44119UC	40	41408UG	56	
41306TC	20	48619TC	26	44011EC	30	43808EC	34	41515EC	46	44121UC	40	41811UG	56	
41405TC	22	48625TC	26	44016EC	30	43808IC	34	42019EC	46	44125UC	40	42311UG	56	
41406TC	22	48626TC	26	44020EC	30	43809EC	34	42523EC	46	44130UC	40	42318UG	56	
41407TC	22	49715TC	26	44020IC	30	44008EC	34	43030EC	46	45716UC	40	42616UG	56	
41410TC	22	49718TC	26	44022EC	30	44008IC	34	ETD		45917UC	40	43019UG	56	
41435TC	22	49725TC	26	44033EC	30	44308EC	34	42929EC	48	46420UC	40	43622UG	56	
41450TC	22	49740TC	26	44317EC	30	44308IC	34	43434EC	48	BLOCK		44229UG	56	
41506TC	22			44721EC	30	44310EC	34	43939EC	48	41106IC	50	PQ		
41605TC	22			45528EC	30	44310IC	34	44444EC	48	41308IC	50	42016UG	58	
41606TC	22			45530EC	30	45810EC	34	44949EC	48	41805IC	50	42020UG	58	
41607TC	22			45724EC	30	45810IC	34	45454EC	48	42014IC	50	42610UG	58	
41610TC	22			46016EC	30	46410EC	34	45959EC	48	42107IC	50	42614UG	58	
41809TC	22			46022EC	30	46410IC	34	47054EC	48	42216IC	50	42620UG	58	
42106TC	22			46527EC	30	49938EC	34			42516IC	50	42625UG	58	
42109TC	22			47133EC	30	ER				43208IC	50	43214UG	58	
42206TC	22			47228EC	30	40906EC	36			43618IC	50	43220UG	58	
42207TC	22			48020EC	30	41126EC	36			43808IC	50	43230UG	58	
42212TC	22			49928EC	30	41308EC	36			44008IC	50	43535UG	58	
42506TC	22					41308IC	36			44020IC	50	44040UG	58	
42507TC	22					41426EC	36			44308IC	50	45050UG	58	
42508TC	22					41826EC	36			44310IC	50	RM		
42712TC	24					42014EC	36			45810IC	50	41110UG	60	
42908TC	24					42014IC	36			46410IC	50	41510UG	60	
42915TC	24					42313EC	36			49316IC	50	41812UG	60	
43113TC	24					42517EC	36			49925IC	50	41912UG	60	
43205TC	24					42517IC	36			49938FB	50	42013UG	60	
43610TC	24					42521EC	36			49966FB	50	42316UG	60	
43615TC	24					43021EC	36			49985FB	50	42819UG	60	
43620TC	24					43021IC	36			EP		43723UG	60	
43806TC	24					43225EC	36			40707UG	52	44230UG	60	
43813TC	24									41010UG	52			
43825TC	24									41313UG	52			
44015TC	24									41717UG	52			
										42120UG	52			

Index

	Applications & Materials 2-15		EFD Cores..... 46-47
	Gapped Cores..... 16-19		ETD Cores..... 48-49
	Toroids..... 20-27		Block Cores..... 50-51
	E, I Cores..... 28-31		EP Cores..... 52-53
	Planar E, I Cores..... 32-35		Pot Cores..... 54-55
	ER Cores..... 36-37		RS/DS Cores..... 56-57
	U, I Cores..... 38-39		PQ Cores..... 58-59
	UR Cores..... 40-41		RM Cores..... 60-61
	EC Cores..... 42-43		Hardware..... 62
	EER Cores..... 44-45		Design Guides..... 63-67

Applications & Materials



Ferrites are dense, homogenous ceramic structures made by mixing iron oxide with oxides or carbonates of one or more metals such as zinc, manganese, nickel or magnesium. They are pressed, then fired in a kiln at 1,000 - 1,500°C and machined as needed to meet various operational requirements. Ferrite parts can be easily and economically molded into many different geometries. A diverse set of materials, providing a range of desired electrical and mechanical properties, are available from Magnetics.

Magnetics' ferrite cores are manufactured for a wide variety of applications. Magnetics has the leading MnZn ferrite materials for power transformers, power inductors, wide-band transformers, common mode chokes, as well as many other applications.

ADVANTAGES OF MAGNETICS' FERRITES

- The widest range of toroid sizes in power and high permeability materials
- Superior toroid coatings available in epoxy and Parylene C
- Standard gapping to precise inductance or mechanical dimension: wide range of coil former and assembly hardware available
- The full range of standard planar E and I cores
- Rapid prototyping capability for new development

FERRITE APPLICATIONS

APPLICATIONS	DESIRED PROPERTIES	PREFERRED MATERIALS	AVAILABLE SHAPES
Broadband Transformers	Low loss, high μ . Good frequency response.	J, W, M	Pot cores, Toroids, E, U & I cores, RM cores, EP cores
Common Mode Chokes	Very high μ (permeability).	J, W, M	Toroids, E Cores
Converter and Inverter Transformers	Low losses, high saturation.	F, L, P, R, T	Toroids, E, U & I cores, Pot cores, RS cores, Planar cores
Differential Mode Inductors	Low losses, high temperature stability, good stability across load conditions.	F, P, R, T	Gapped Pot cores, EP cores, E cores, RM cores, Planar cores, PQ cores
Linear Filters and Sensors	Good loss factor, linearity and temperature linearity at low drive level.	C, E, V	Pot cores, Toroids
Narrow Band Transformers	Moderate Q, high μ , high stability.	F, J	Pot cores, Toroids, RM cores, EP cores
Noise Filters	High μ , good frequency response.	J, W, M	Toroids
Power Inductors	Low losses at high flux densities and temperatures. High saturation. Good stability across load conditions.	F, L, P, R, T	Pot cores, E cores, PQ cores, RM cores, Planar cores
Power Transformers	High μ and low losses at high flux densities and temperatures. High saturation. Low exciting currents.	F, L, P, R, T	Ungapped Pot cores, E, U & I cores, Toroids, EP cores, RS cores, DS cores, PQ cores, Planar cores
Pulse Transformers	High μ , low loss, high B saturation.	J, W, M	Toroids
Telecom Inductors	Low losses, high temperature stability, good stability across load conditions.	F, P, R, T	Pot cores, EP cores, E cores, RM cores, Planar cores

Ferrite Materials



			INDUCTORS & POWER TRANSFORMERS					EMI/RFI FILTERS & BROADBAND TRANSFORMERS			LINEAR FILTERS & SENSORS		
MATERIAL			L	R	P	F	T	J	W	M	C	E	V
Initial Permeability	μ_i		750 ±25%	2,300 ±25%	2,500 ±25%	3,000 ±20%	3,000 ±25%	5,000 ±20%	10,000 ±30%	15,000 ±30%	900 ±25%	2,000 ±25%	2,300 ±25%
Maximum Usable Frequency (50% roll-off)	f	MHz	≤6	≤1.8	≤1.8	≤1.5	≤1.5	≤0.7	≤0.5	≤0.12	≤8	≤3	≤1.5
Relative Loss Factor X 10 ⁻⁶ 25°C		$\frac{\tan \delta}{\mu_{iAC}}$						≤15 100 kHz	≤7 10 kHz	≤10 10 kHz	≤10 300 kHz	≤3 100 kHz	≤5 100 kHz
Curie Temperature	T _c	°C	>280	>210	>210	>210	>220	>145	>135	>130	>200	>160	>170
Flux Density @ 1,194 A/m (15 Oe) 25°C	B _m 10 kHz	G mT	5,200 520	4,700 470	4,700 470	4,700 470	5,300 530	4,300 430	3,900 390	4,700 470	3,800 380	3,600 360	4,400 440
Remanence 25°C	B _r	G mT	1,500 150	1,600 160	1,600 160	1,500 150	1,500 150	1,000 100	800 80	2,700 270	1,500 150	700 70	1,500 150
Power Loss (PL) Sine Wave in mW/cm ³ (typical)	25 kHz 200 mT (2,000 G)	@25°C		90	180	60	80						
		@60°C		65	110	55	75						
		@100°C		60	65	90	70						
		@120°C		65	110	125	75						
	100 kHz 100 mT (1,000 G)	@25°C		87	70	70	65						
		@60°C		64	50	65	57						
		@100°C		58	65	110	55						
		@120°C		64	45	150	58						
	500 kHz 50 mT (500 G)	@25°C	290										
		@60°C	150										
		@100°C	115	175	300		150						
		@120°C	130										
Resistivity	ρ	Ω·m	10	5	5	5	5	0.5	0.1	0.5	2	2	1
Density	δ	g/cm ³	4.8	4.8	4.8	4.8	4.8	4.8	4.9	5.0	4.7	4.7	4.8

Ferrite Materials



TYPICAL MECHANICAL PROPERTIES OF FERRITE MATERIALS

MECHANICAL DATA		UNITS	THERMAL DATA		UNITS
Bulk Density	4.85	g/cm ³	Coefficient of Linear Expansion	10.5x10 ⁻⁶	°C ⁻¹
Tensile Strength	5.0, 7.0x10 ³	kgf.mm ⁻² , lbs.in ⁻²	Specific Heat (25°)	800	J/kgK
Compressive Strength	45, 63x10 ³	kgf.mm ⁻² , lbs.in ⁻²	Thermal Conductivity (25-85°C)	3500-4300	μW.mm ⁻¹ .°C ⁻¹
Youngs Modulus	12.4x10 ³ , 1.8x10 ⁷	kgf.mm ⁻² , lbs.in ⁻²		35-43	mW.cm ⁻¹ .°C ⁻¹
Hardness (Knoop)	650 Typical			.0083-.010	cal.s ⁻¹ .cm ⁻¹ .°C ⁻¹
Resistivity	10 ² -10 ³	ohm-cm			



R Material

A medium frequency multi-purpose power transformer, inductor and filter material. Widely available in shapes and toroids. Engineered for lowest losses between 90 - 100°C.

Initial Perm (25°C; ≤ 10 kHz) **2,300 ± 25%**
 Saturation Flux Density (4,700 G at 15 Oe, 25°C) 470 mT, 11.9 A-T/cm
 Curie Temperature 210°C

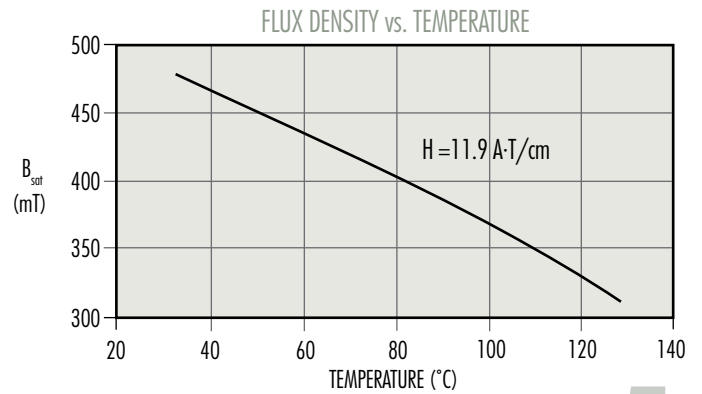
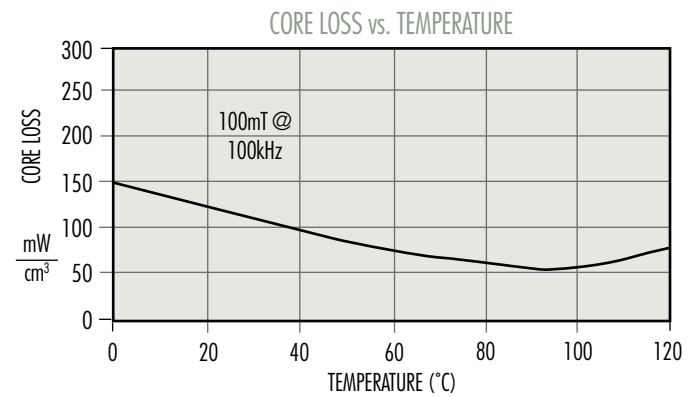
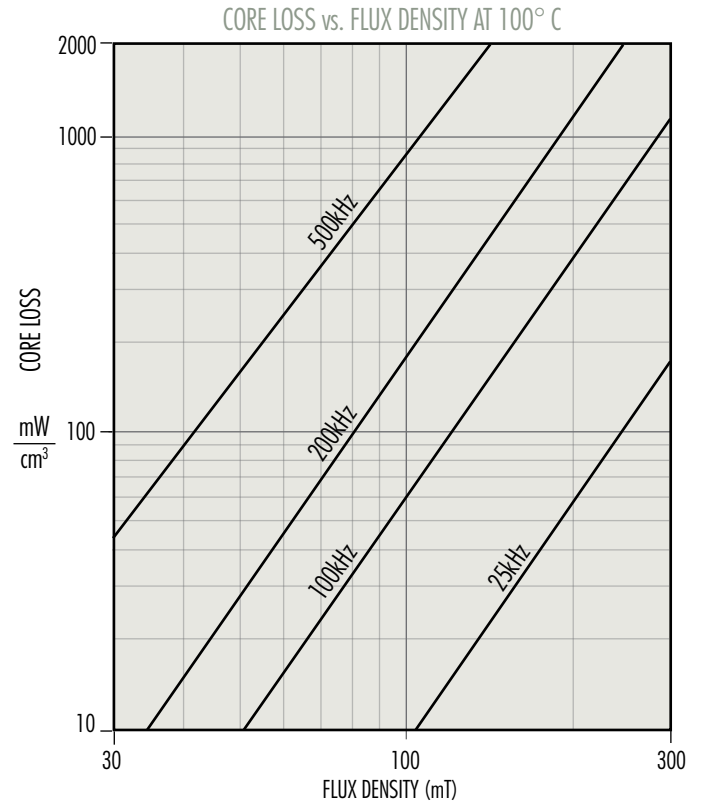
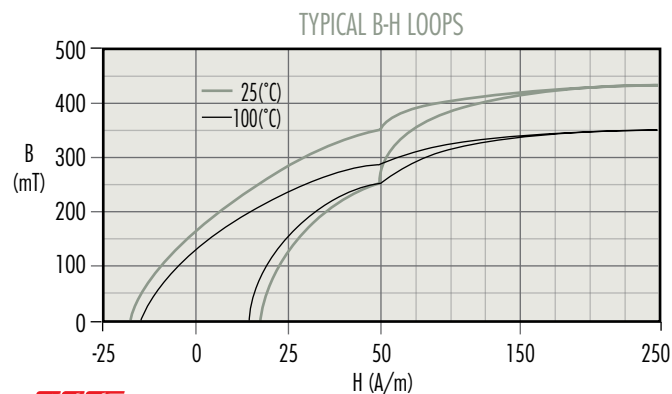
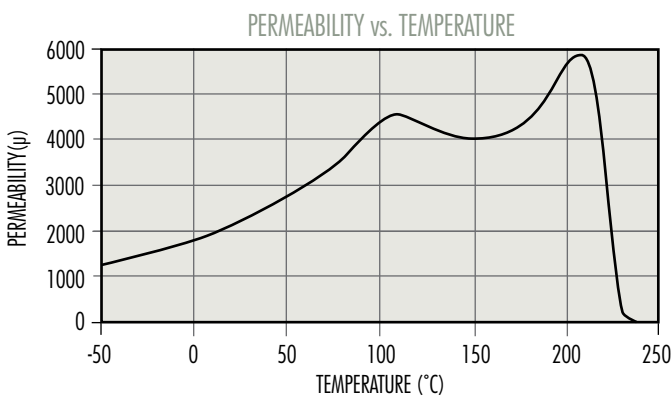
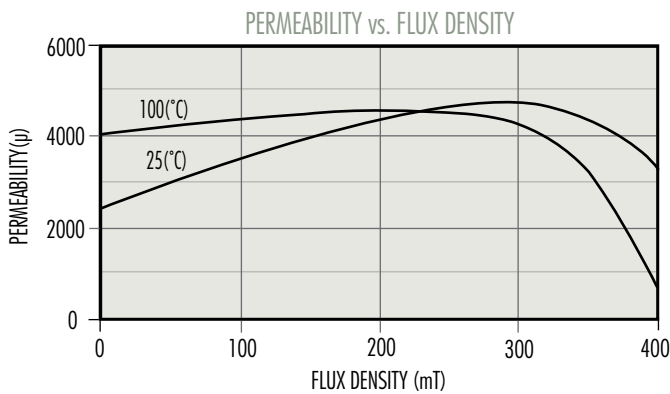
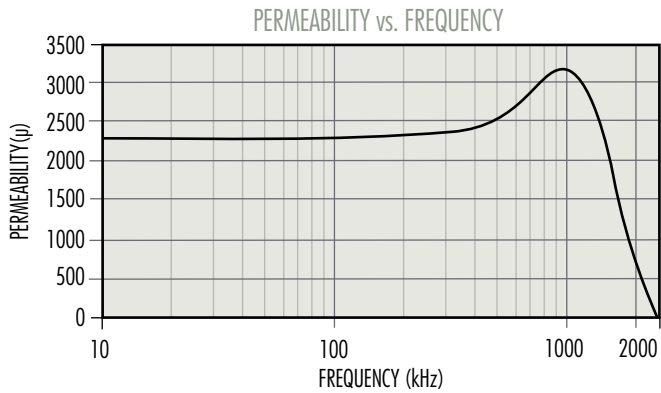

P Material

A low-medium frequency general-purpose power converter material. Engineered for lowest losses between 80 - 100°C. Available in almost all core sizes and shapes.

Initial Perm (25°C; ≤ 10 kHz) **2,500 ± 25%**
 Saturation Flux Density (4,700 G at 15 Oe, 25°C) 470 mT, 11.9 A·T/cm
 Curie Temperature 210°C

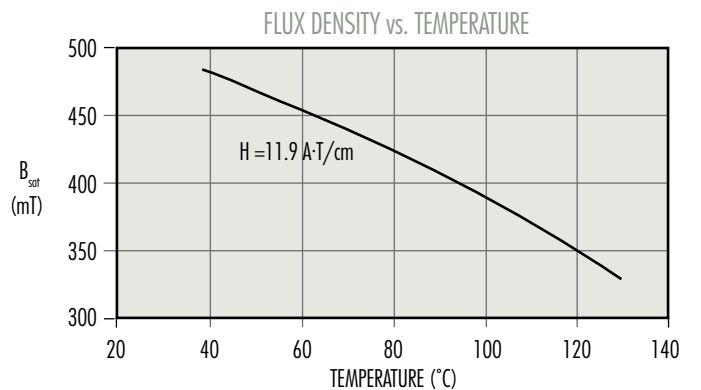
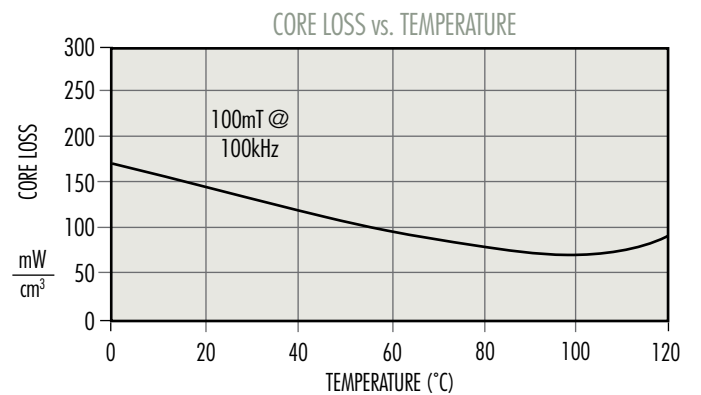
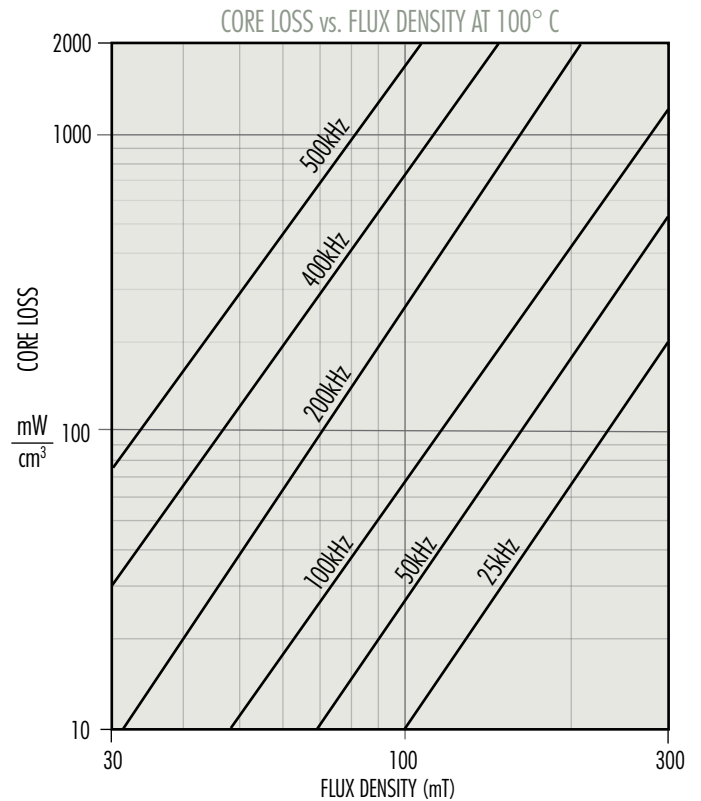
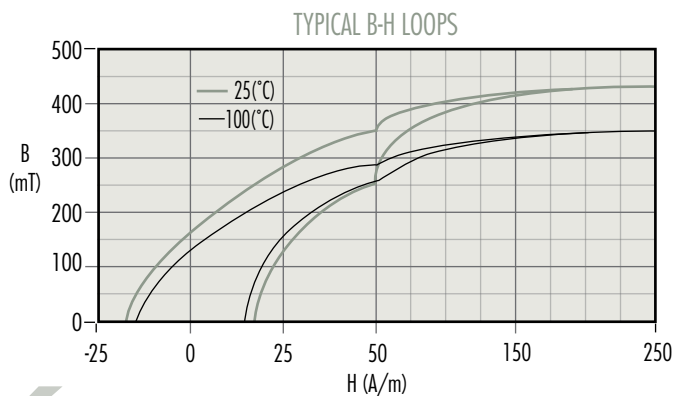
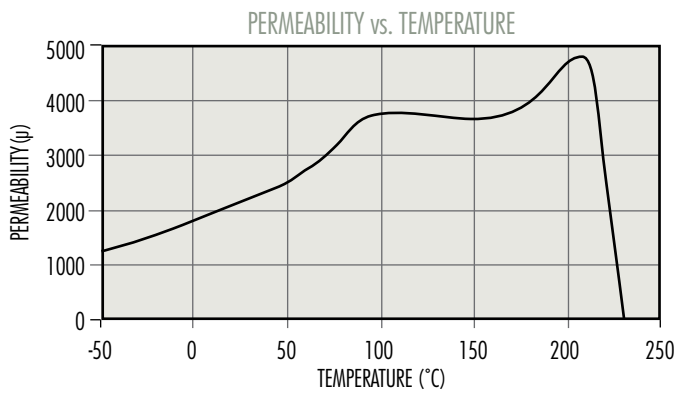
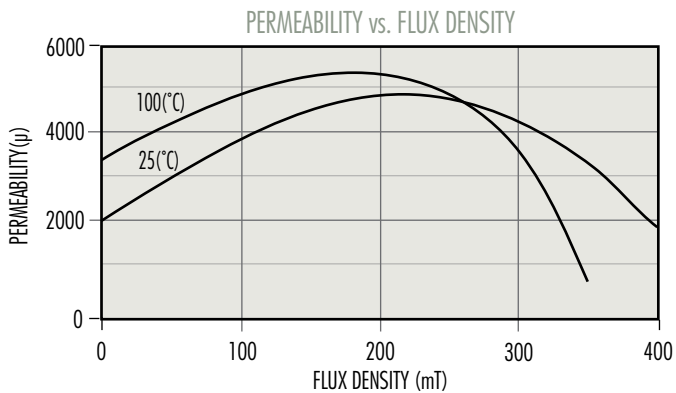
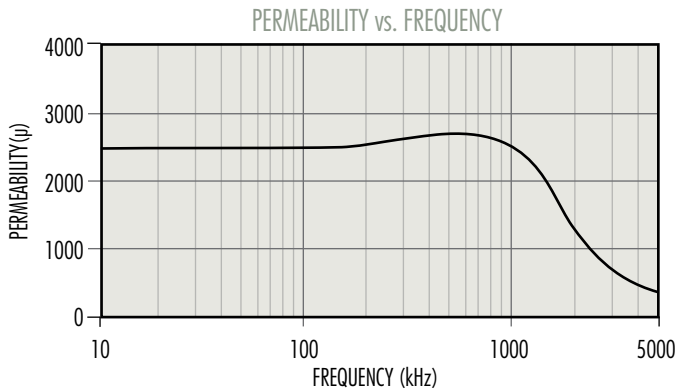

F Material

A medium frequency general-purpose power transformer, inductor and filter material. Slightly higher in perm than P or R Material. Engineered for lowest losses between 50 - 80°C.

Initial Perm (25°C; ≤ 10 kHz) **3,000 ± 20%**
 Saturation Flux Density (4,700 G at 15 Oe, 25°C) 470 mT, 11.9 A-T/cm
 Curie Temperature 210°C

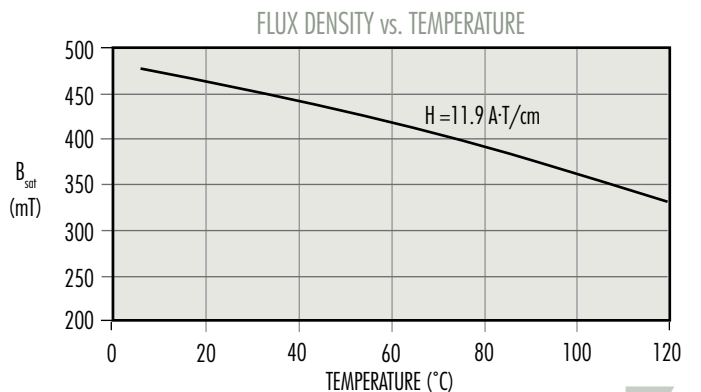
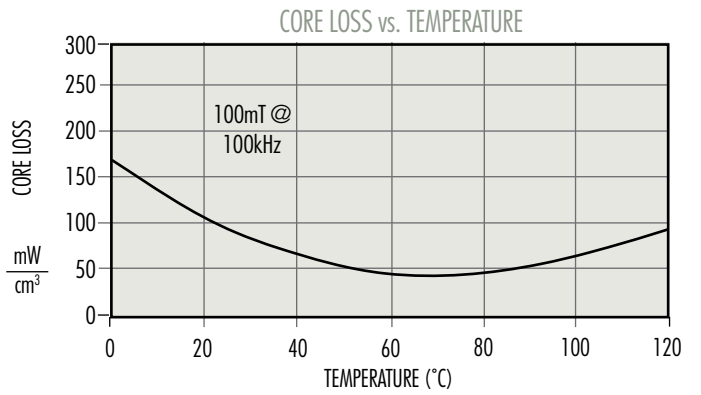
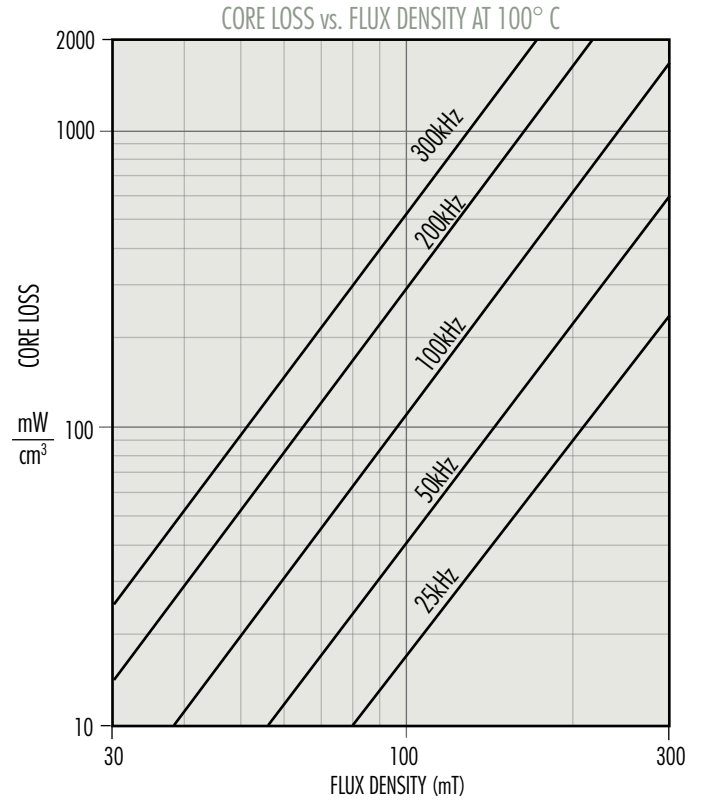
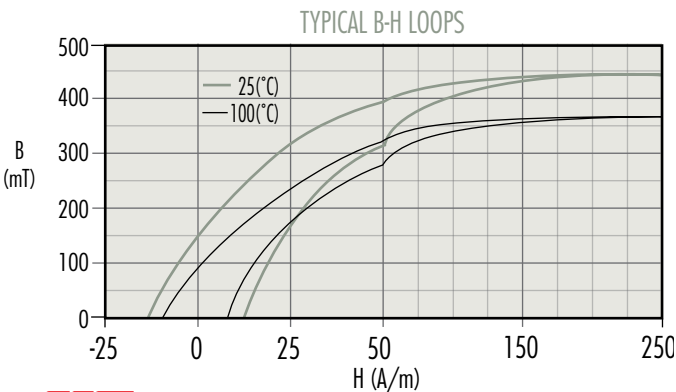
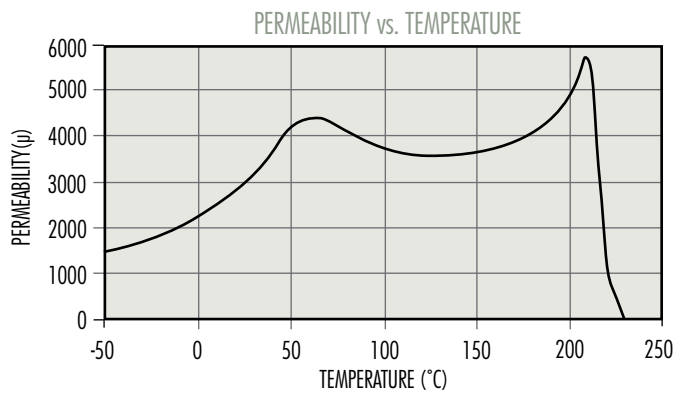
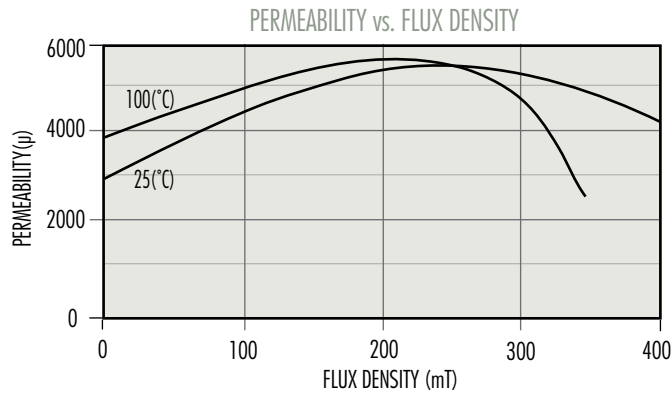
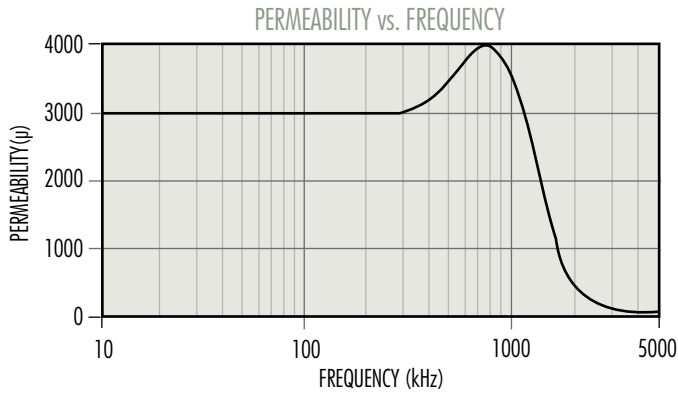

T Material

A power material for transformers and inductors operating from 20 kHz to 750 kHz. T material offers stability in both perm and losses over a wide temperature range.

Initial Perm (25°C; ≤ 10 kHz) **3,000 ± 25%**
 Saturation Flux Density (5,300 G at 15 Oe, 25°C) 530 mT, 11.9 A-T/cm
 Curie Temperature 220°C

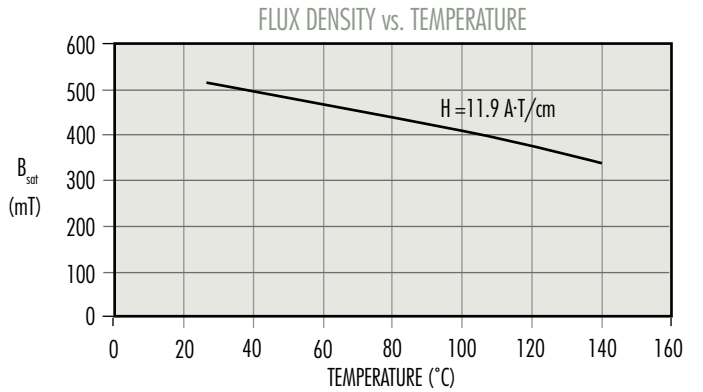
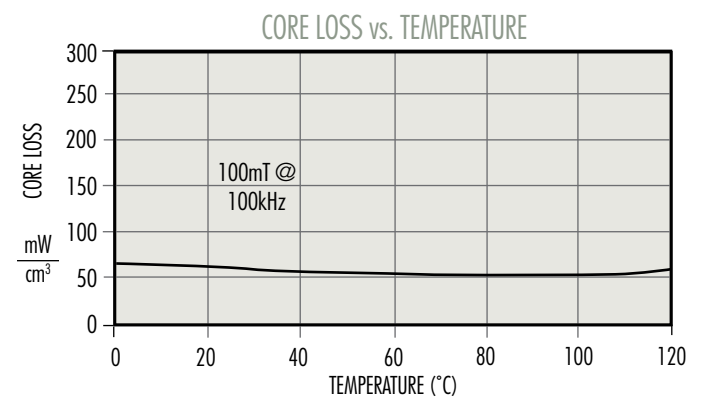
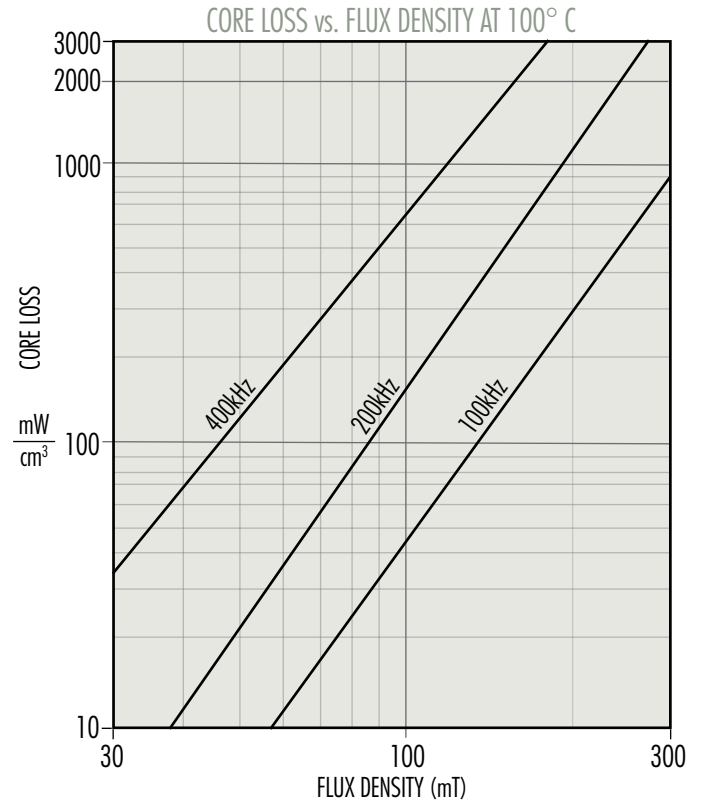
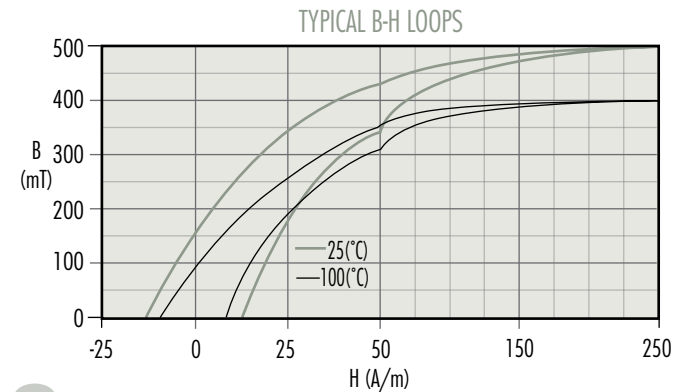
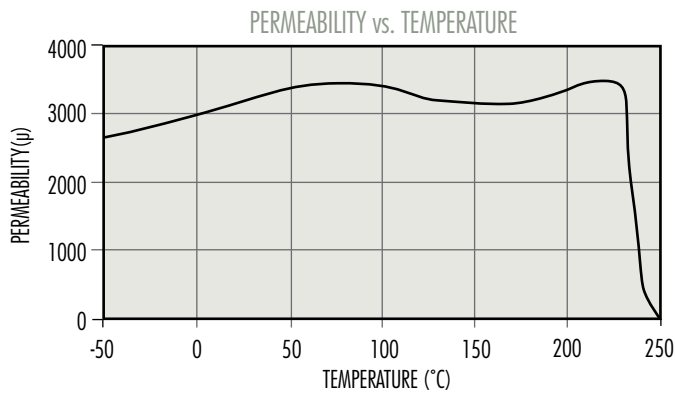
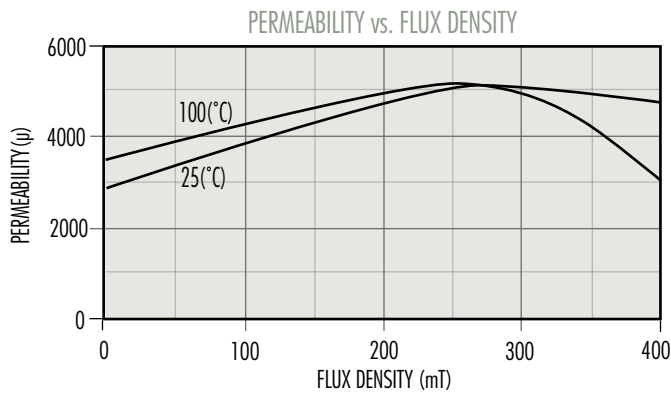
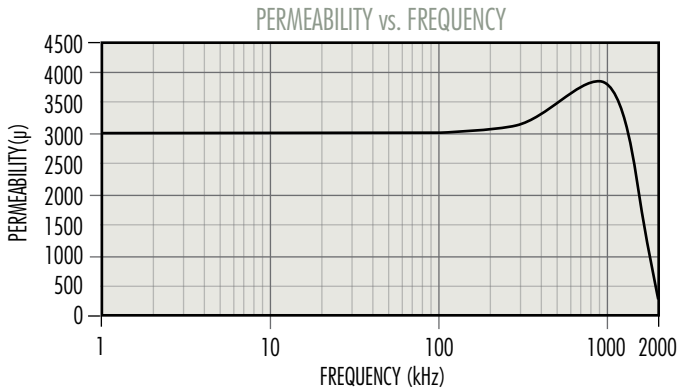

L Material

A high-frequency high-temperature power material.
L material is optimized for transformers and inductors
from 500 kHz – 3 MHz. Core losses are minimized
between 70 – 100°C.

Initial Perm (25°C; ≤ 10 kHz) $750 \pm 25\%$
Saturation Flux Density (5,200 G at 15 Oe, 25°C) 520 mT, 12 A-T/cm
Curie Temperature 280°C

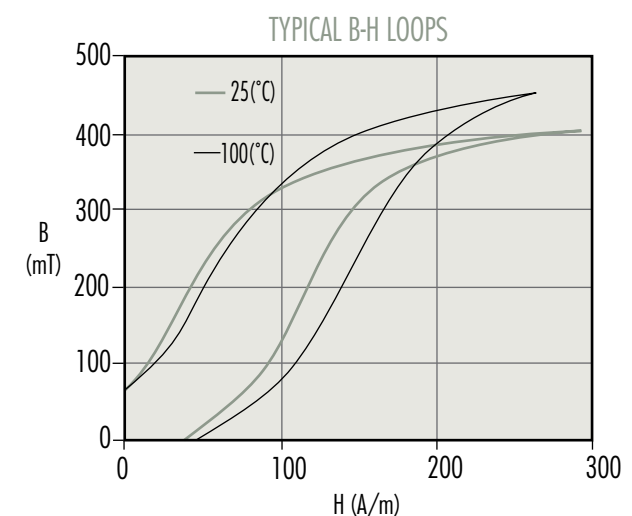
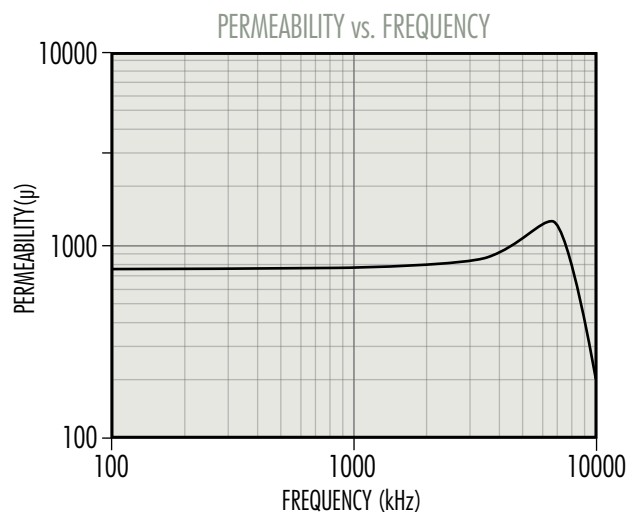
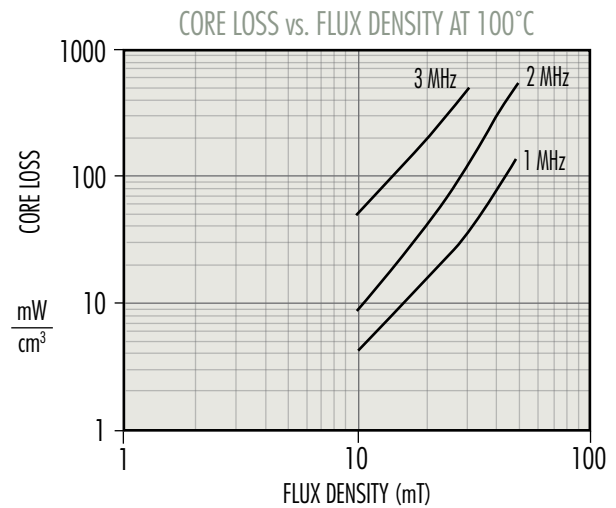
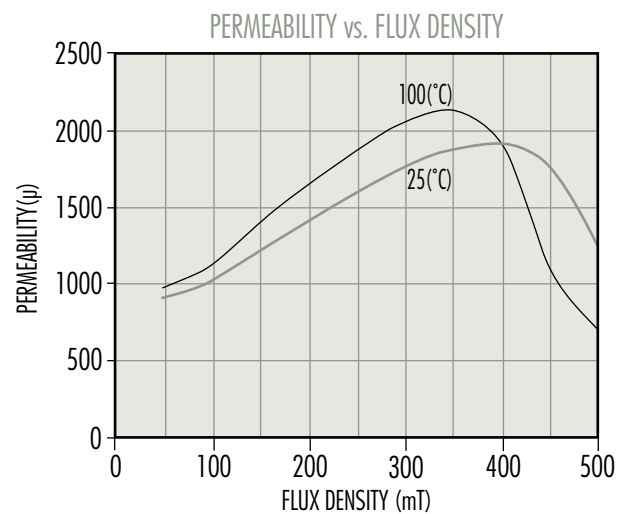
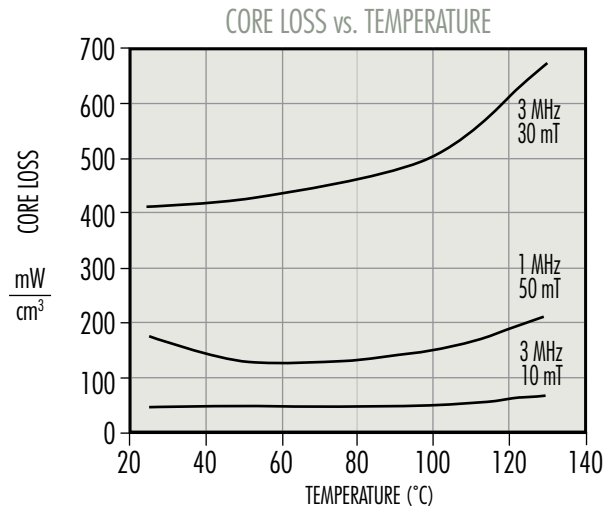
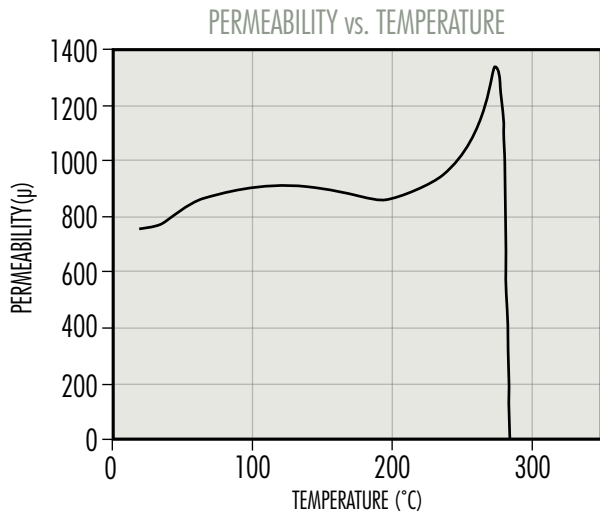

C Material

C Material works well for Telecom Filters, Wideband, Matching and Pulse transformer applications, and High Q inductors.

Initial Perm (25°C; ≤ 10 kHz), Uncoated **900 \pm 25%**
Saturation Flux Density 380 mT, 11.9 A-T/cm (3,800 G at 25°C, 15 Oe)
Curie Temperature 200°C

PERMEABILITY vs. TEMPERATURE

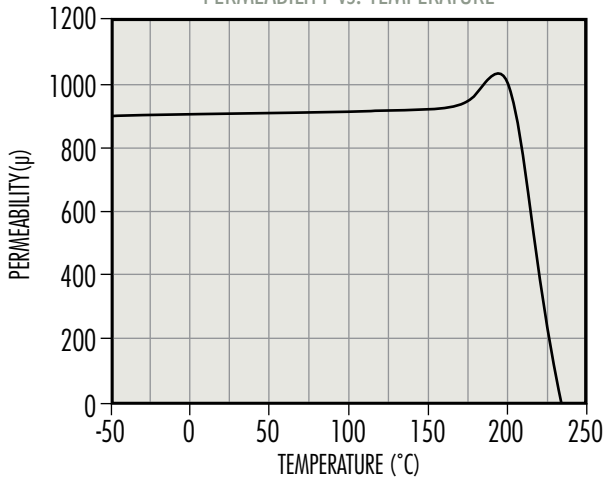

PERMEABILITY vs. FREQUENCY

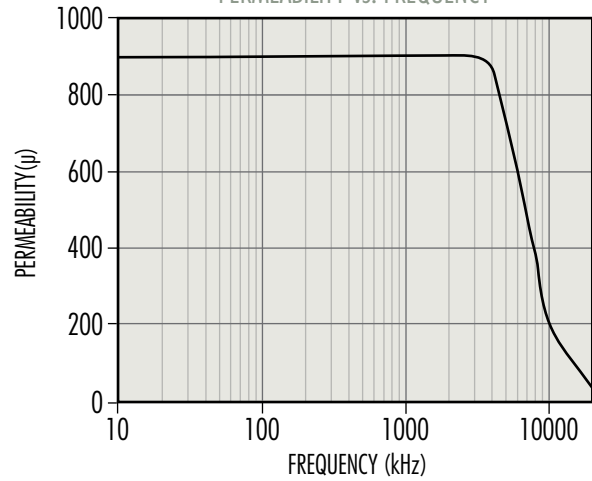

TYPICAL B-H LOOPS

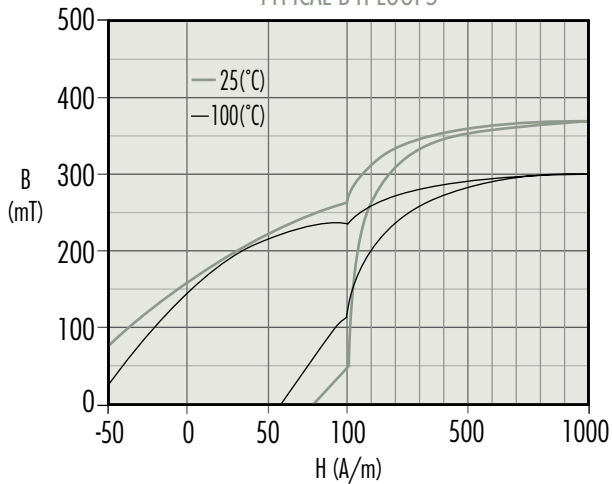

E Material

E Material works well for Telecom Filters, Wideband, Matching and Pulse transformer applications, and High Q inductors.

Initial Perm (25°C; ≤ 10 kHz), Uncoated **2,000 \pm 25%**
 Saturation Flux Density 360 mT, 11.9 A-T/cm (3,600 G at 25°C, 15 Oe)
 Curie Temperature 160°C

PERMEABILITY vs. TEMPERATURE

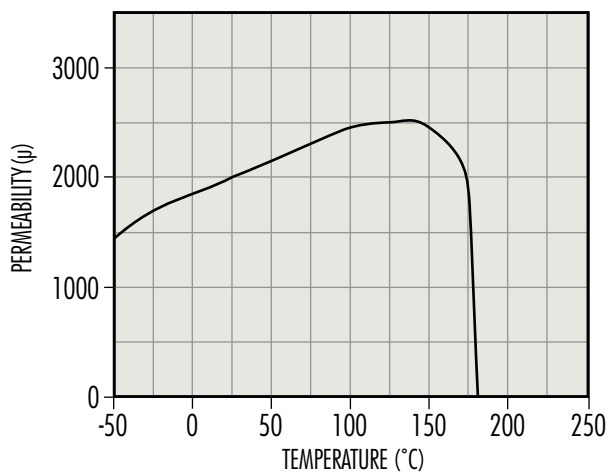

PERMEABILITY vs. FREQUENCY

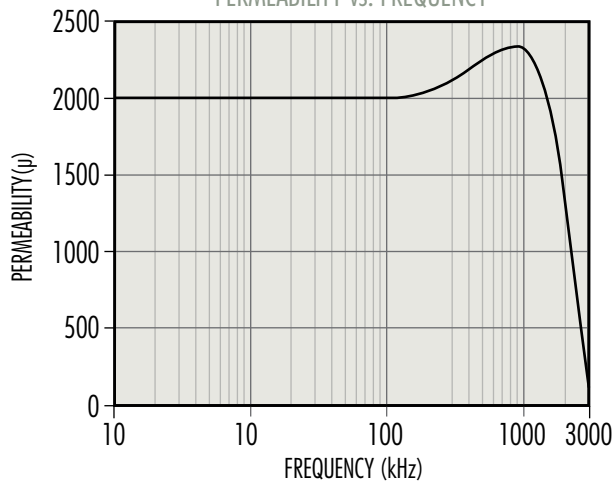

TYPICAL B-H LOOPS

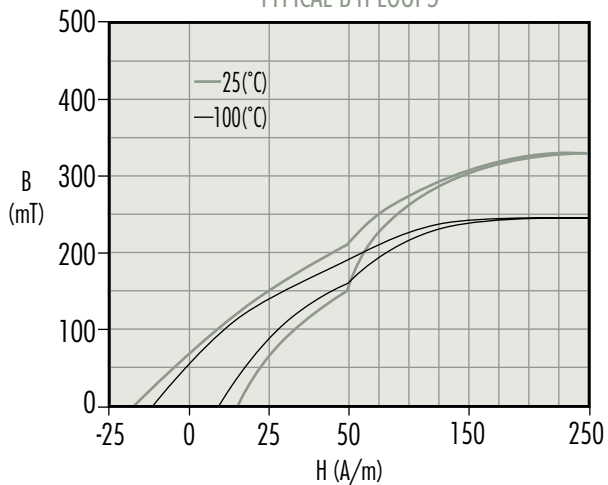

V Material

V Material works well for Telecom Filters, Wideband, Matching and Pulse transformer applications, and High Q inductors.

Initial Perm (25°C; ≤ 10 kHz), Uncoated **2,300 ± 25%**

Saturation Flux Density 440 mT, 11.9 A·T/cm (4,400 G at 25°C, 15 Oe)

Curie Temperature 170°C

PERMEABILITY vs. TEMPERATURE

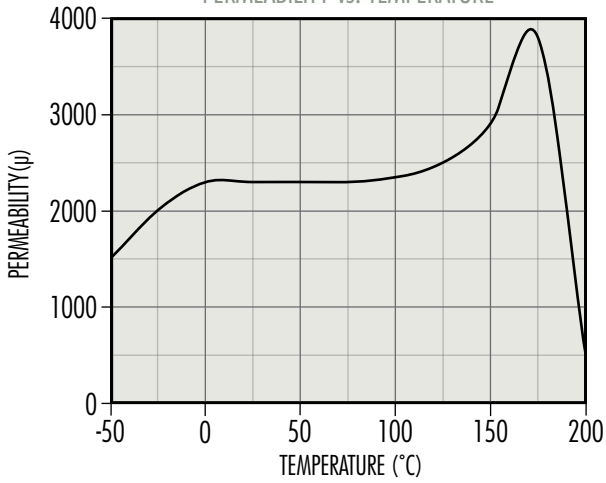

PERMEABILITY vs. FREQUENCY

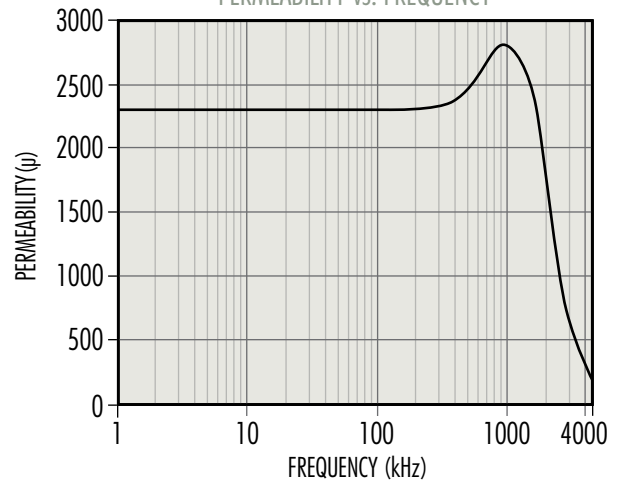

TYPICAL B-H LOOPS

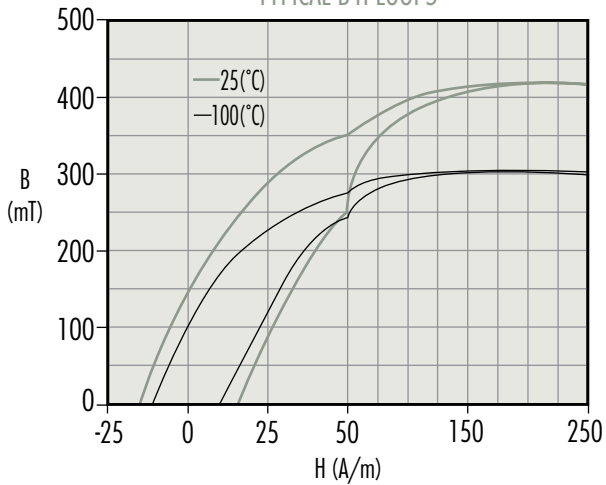

J Material

A medium perm general-purpose material. Well suited both for EMI/RFI filtering and broadband transformers.

Initial Perm (25°C; ≤ 10 kHz) **5,000 ± 20%**
 Saturation Flux Density (4,300 G at 15 Oe, 25°C) 430 mT, 11.9 A-T/cm
 Curie Temperature 145°C

PERMEABILITY vs. TEMPERATURE

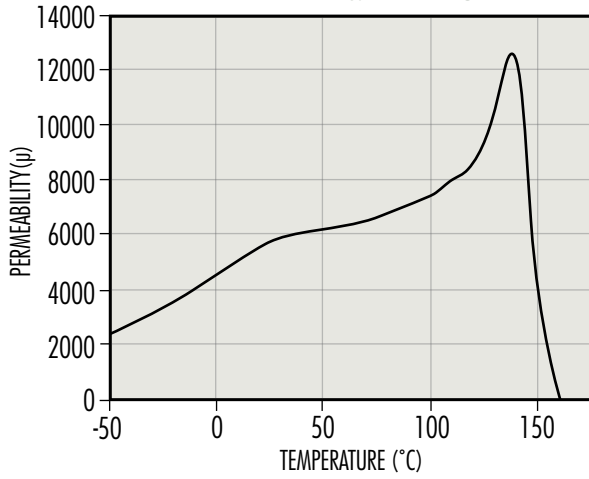

PERMEABILITY vs. FREQUENCY

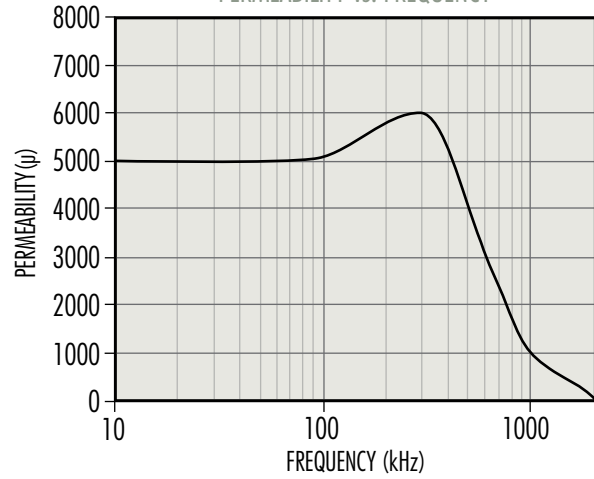

PERMEABILITY vs. DC BIAS

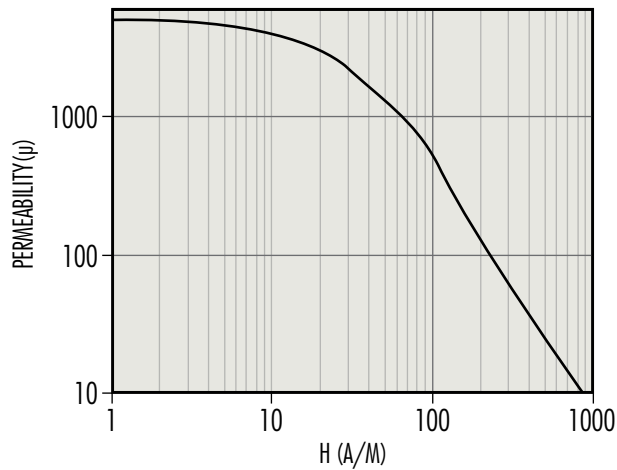

TYPICAL B-H LOOPS

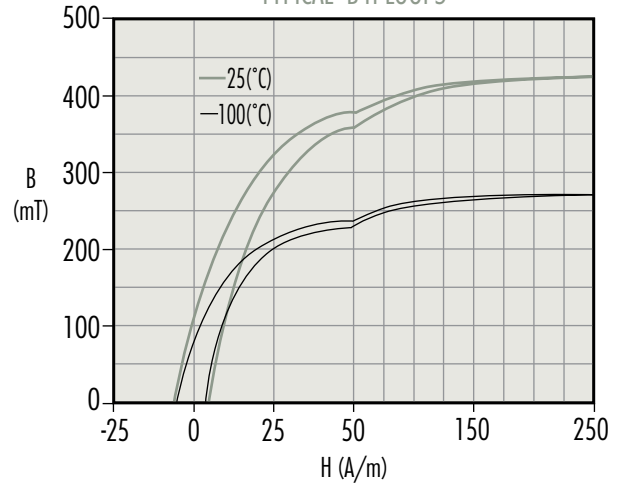

W Material

A high permeability material used for EMI/RFI suppression, common mode chokes, pulse and broadband transformers.

Initial Perm (25°C; ≤ 10 kHz) **10,000 ± 30%**
 Saturation Flux Density (3,900 G at 15 Oe, 25°C) 390 mT, 11.9 A-T/cm
 Curie Temperature 135°C

PERMEABILITY vs. TEMPERATURE

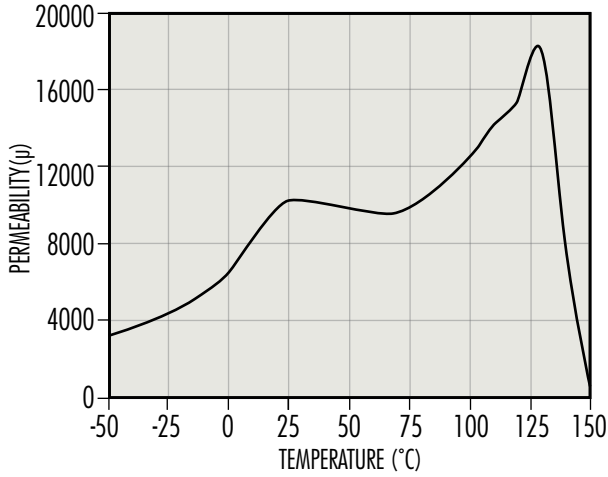

PERMEABILITY vs. FREQUENCY

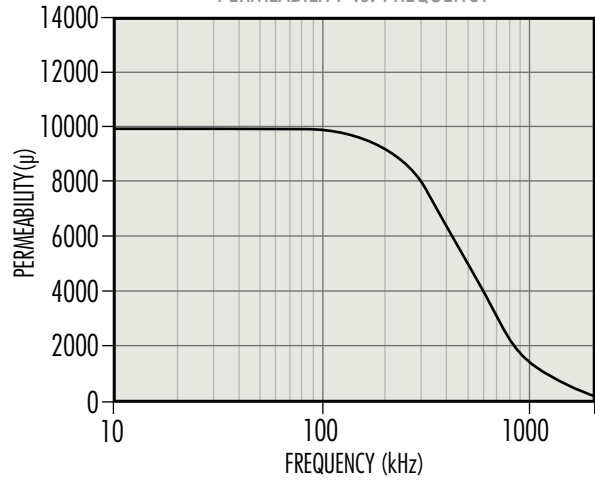

PERMEABILITY vs. DC BIAS

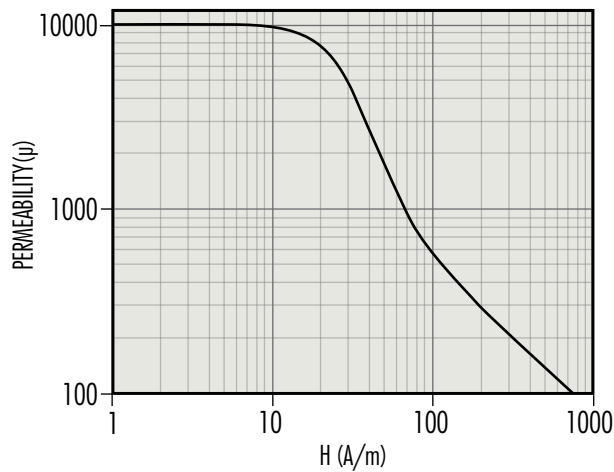

TYPICAL B-H LOOPS

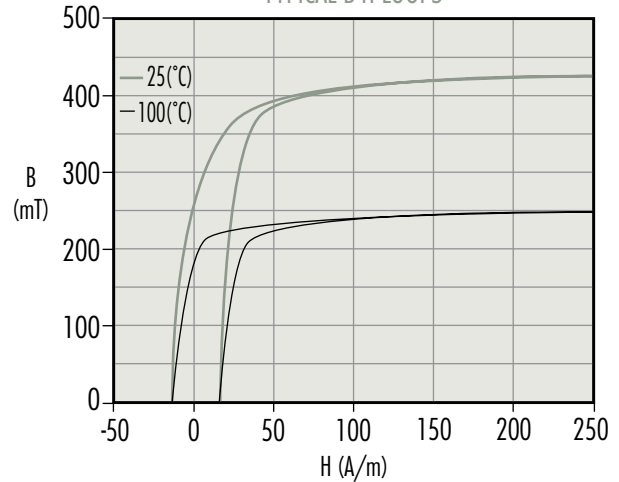

M Material

Highest permeability material used for EMI/RFI suppression, common mode chokes, pulse and broadband transformers.

Initial Perm (25°C; ≤ 10 kHz) **15,000 \pm 30%**
 Saturation Flux Density (4,700 G at 15 Oe, 25°C) 470 mT, 11.9 A-T/cm
 Curie Temperature 130°C

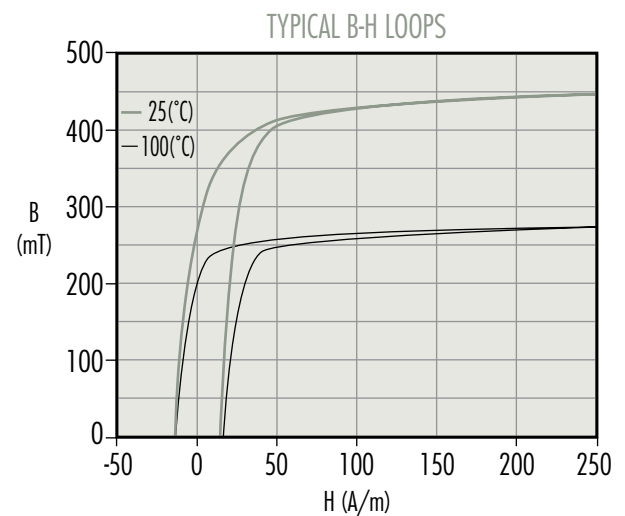
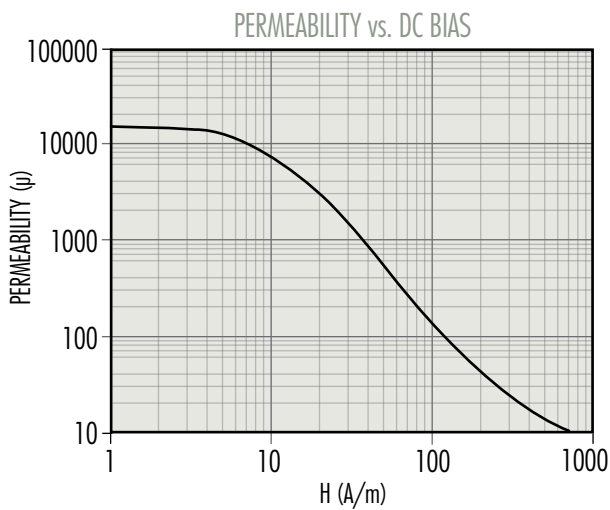
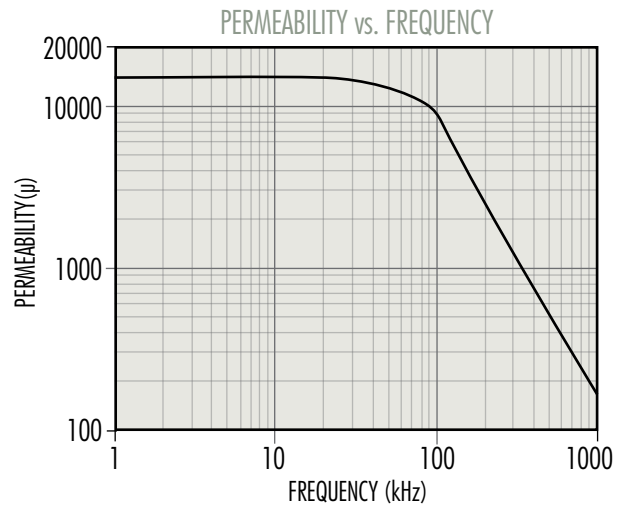
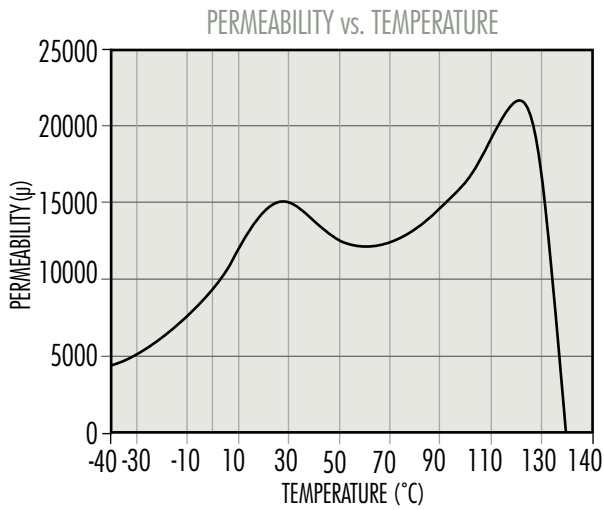

Gapped Cores

How To Order

Part Number



Gap Code

The letter indicates the type of gap and a three-digit number defines the value.

CODE	MEANING	EXAMPLE
A _ _ _	A_L (if <1000)	DF42311 A275 (A _L =275)
X _ _ _	A_L if 1000 or greater (add 1000 to code)	OP44721 X250 (A _L =1250)
F _ _ _	A_L if <100, non-integer (divide code by 10)	OR42510 F807 (A _L =80.7)
G _ _ _	Depth of Grind in mils (1000 ^{ths} of an inch)	OF44317 G079 (Gap=0.079")
M _ _ _	Depth of Grind , mm (divide code by 10)	OF43019 M015 (Gap=1.5 mm)

A_L is inductance factor, mH/1000 Turns, or nH/T².

Either the A_L or the depth of grind (not both) is controlled during production of gapped cores.

See the chart on pages 17-19 for tolerances.

Gap-to-Gap vs Ungapped-to-Gap Core Sets

"Gap-to-gap combination" means the gap is symmetrical. Half of the total gap is removed from each piece.

"Ungapped-to-gap combination" means an asymmetrical gap; the entire gap is taken from one piece, and the other piece is ungapped.

For an E-core gapped to an A_L value when mated with the standard I-core, add "-EI" to the end of the part number.

Gapping for A_L

Inductors are commonly designed with an airgap in the magnetic path where the center legs or center posts of two ferrite pieces meet. This airgap allows the inductance to be controlled to a tight tolerance, and it allows the inductor to support a defined level of DC current without saturating. Inductors are commonly designed with an airgap in the magnetic path where the center legs or center posts of two ferrite pieces meet. This airgap allows the inductance to be controlled to a tight tolerance, and it allows the inductor to support a defined level of DC current without saturating. In most applications, defining the gap with the A_L results in inductors with the least variation.

When specifying and ordering E cores (including EC, EFD, EER, ETD, and Planar E cores) gapped to an A_L, it is important to note which cores are produced in gap-to-gap combination, because two gapped pieces are assembled to achieve the A_L. Alternatively, for E cores provided ungapped-to-gap, an ungapped piece must be used with a gapped piece to achieve the A_L. Pot, RS, DS, RM, PQ, and EP cores are sold as sets whether the combination is gap-to-gap or ungapped-to-gap.

A_L testing and limits are calculated to three significant digits based on the nominal value. For example, A_L=99±3% is interpreted as 96.0 Minimum, 99.0 Nominal, and 102.0 Maximum.

Magnetics tests gapped A_L values with full bobbins, usually 100 turns, or 250 turns for deep gaps. The drive level is low (0.5 mT) and the frequency is set low enough to avoid resonance effects. Measured inductance in an application may vary significantly from the theoretical value due to low turns, low bobbin fill, leakage effects, resonance effects, or elevated drive levels.

It is important for users to verify the correlation between the test of the core and the specific test being applied to the inductor or transformer. Planar E cores, Planar RM, and Planar PQ cores are especially susceptible to correlation discrepancies.

Gapping for Depth of Grind

Even though controlling A_L is usually the way to get the best consistency in finished inductor performance, in some cases the best results are seen when the depth of grind is specified instead. This is generally in cases where the gap dimension is quite large (the A_L is low), because variation in the inductance of the wound device is dominated by variation in the windings, especially if the number of turns is low.

For parts ordered in pieces (E cores), the depth of grind is given for each piece. To make an ungapped-to-gap set, use one piece of each. For example, use OR41808G050 with OR41808EC for an asymmetrical gap of 0.050" ± 0.001. For the same gap, but symmetrical, use two pieces of OR41808G025.

For parts ordered in sets, the depth of grind is given as a total for the set, and may be ungapped-to-gap core pieces or gap-to-gap.

Gapped Cores

Depth of Grind Tolerances

Tolerance Ranges for Pot, RS, DS, RM, PQ, and EP cores

INCHES				MILLIMETERS		GAP CONDITION
GAP	TOLERANCE < 40 mm	TOLERANCE 40 mm to < 60 mm	TOLERANCE ≥ 60 mm	GAP	TOLERANCE	
0.001"–0.038"	± 0.0005"	± 0.00075"	± 0.001"	0.1 mm – 0.9 mm	± 0.03 mm	Ungapped to gap combination
0.039"–0.076"	± 0.001"	± 0.0015"	± 0.002"	1.0 mm – 1.9 mm	± 0.04 mm	Ungapped to gap combination (Except if the gap is more than 10% of the minimum bobbin depth for the set*, then gap-to-gap combination.)
0.077"–0.114"	± 0.002"	± 0.003"	± 0.004"	2.0 mm – 2.9 mm	± 0.07 mm	Gap to gap combination (Except if the gap is less than 10% of the minimum bobbin depth for the set*, then ungapped-to-gap combination.)
0.115"–0.152"	± 0.002"	± 0.003"	± 0.004"	3.0 mm – 3.8 mm	± 0.07 mm	Gap to gap combination
0.153"–0.228"	± 0.004"	± 0.006"	± 0.008"	3.9 mm – 5.0 mm	± 0.12 mm	Gap to gap combination

*The bobbin depth for the set is the 2D dimension or 2 times the D dimension

Tolerance Ranges for E, EC, ER, EER, EFD, ETD and Planar E cores

INCHES				MILLIMETERS	
GAP	TOLERANCE < 40 mm	TOLERANCE 40 mm to < 60 mm	TOLERANCE ≥ 60 mm	GAP	TOLERANCE
0.001"–0.038"	± 0.0005"	± 0.00075"	± 0.001"	0.1 mm – 0.9 mm	± 0.03 mm
0.039"–0.076"	± 0.001"	± 0.0015"	± 0.002"	1.0 mm – 1.9 mm	± 0.04 mm
0.077"–0.152"	± 0.002"	± 0.003"	± 0.004"	2.0 mm – 3.8 mm	± 0.07 mm
0.153"–0.228"	± 0.004"	± 0.006"	± 0.008"	3.9 mm – 5.0 mm	± 0.12 mm

Gapped Cores

A_L Value Tolerances

SIZE	GAP TO GAP ± 3%	UNGAPPED TO GAP COMBINATION			
		±3%	±5%	±7%	±10%
E CORES* PAGES 28 - 31					
41203	16-27	28-55	≤86	≤117	≤160
41205	28-47	48-107	≤170	≤229	≤316
41707	22-37	38-89	≤140	≤190	≤259
41808	27-42	43-121	≤192	≤258	≤355
41810	44-74	75-235	≤376	≤512	≤704
42510	37-61	62-200	≤318	≤432	≤595
42515	28-43	44-210	≤333	≤452	≤616
42520	107-190	191-397	≤643	≤874	≤1202
42530	45-72	73-409	≤655	≤891	≤1225
43007	42-67	68-307	≤491	≤668	≤919
43009	55-91	92-222	≤353	≤475	≤653
43515	54-87	88-429	≤687	≤934	≤1284
43520	65-111	112-461	≤738	≤1003	≤1380
44011	59-95	96-642	≤1029	≤1400	≤1940
44016	52-83	84-545	≤872	≤1185	≤1629
44020	78-126	127-916	≤1480	≤1999	
44022	94-156	157-1187	≤1903	≤1999	
44317	81-136	137-762	≤1222	≤1676	≤1999
44721	107-180	181-1188	≤1920	≤1999	
45528	113-186	187-500	≤1999		
45530	150-360	361-600	≤1999		
45724	129-218	219-450	≤1999		
46016	102-129	130-1231	≤1999		
46527	142-235	236-650	≤1999		
47133	150-285	286-950	≤1999		
47228	120-199	200-1823	≤1999		
48020	99-158	159-1922	≤1999		
49928	150-285	286-975	≤1999		
EC CORES PAGES 42 - 43					
43517	49-79	80-438	≤702	≤954	≤1312
44119	61-98	99-627	≤1004	≤1365	≤1891
45224	76-123	124-911	≤1471	≤1999	
47035	83-135	136-1403	≤1999		

*These tolerances also apply to E-I combination.

SIZE	GAP TO GAP ±3%	UNGAPPED TO GAP COMBINATION			
		±3%	±5%	±7%	±10%
PLANAR E CORES* PAGES 32 - 35					
41425	19-35	36-76	≤122	≤166	≤228
41434	17-31	32-77	≤123	≤167	≤230
41805	18-32	33-205	≤329	≤448	≤617
42107	35-66	67-188	≤304	≤414	≤569
42216	78-141	142-405	≤656	≤892	≤1239
43208	118-216	217-643	≤1040	≤1427	≤1964
43618	119-222	223-673	≤1088	≤1491	≤1999
43808	173-315	316-956	≤1547	≤1999	
44008	106-189	190-507	≤821	≤1116	≤1548
44308	201-367	368-1130	≤1828	≤1999	
44310	169-305	306-1130	≤1828	≤1999	
45810	266-481	482-1496	≤1999		
46410	379-701	702-1999			
49938	336-594	595-1999			
ER CORES* PAGES 36 - 37					
40906	15-65	66-70	≤110	≤150	≤200
41126	40-74	75-100	≤140	≤190	≤275
41426	45-84	85-130	≤190	≤250	≤380
41826	50-84	85-200	≤325	≤445	≤650
42313	55-90	91-200	≤525	≤710	≤900
43021	80-169	170-710	≤1050	≤1460	≤1975
EER/ETD CORES PAGES 44 - 45/48 - 49					
43434	55-88	89-500	≤806	≤1095	≤1507
43521	54-86	87-566	≤913	≤1241	≤1707
43939	95-156	157-641	≤1028	≤1398	≤1935
44216	71-117	118-876	≤1415	≤1925	≤1999
44444	73-117	118-881	≤1423	≤1935	≤1999
44949	81-130	131-1075	≤1736	≤1999	
45959	51-118	119-1822	≤1999		
EFD CORES PAGES 46 - 47					
41212	18-29	30-90	≤130	≤170	≤230
41515	19-30	31-81	≤127	≤172	≤236
42019	29-45	46-220	≤350	≤430	≤575
42523	41-66	67-296	≤475	≤646	≤888
43030	50-90	91-450	≤790	≤975	≤1125

Gapped Cores

A_L Value Tolerances

SIZE	GAP TO GAP ± 3%	UNGAPPED TO GAP COMBINATION			
		±3%	±5%	±7%	±10%
EP CORES		PAGES 52 - 53			
40707	25-50	51-75	≤125		≤160
41010	25-55	56-75	≤125		≤160
41313	25-75	76-110	≤175	≤275	≤315
41717	25-100	101-175	≤275	≤400	≤630
42120	25-180	181-450	≤630	≤850	≤1250
POT CORES		PAGES 54 - 55			
40704	25-35	36-62	≤95	≤125	≤175
40905	25-48	49-87	≤135	≤180	≤240
41107	25-75	76-135	≤220	≤285	≤399
41408	71-113	114-210	≤307	≤417	≤574
41811	96-174	175-326	≤523	≤712	≤988
41814	65-135	136-340	≤510	≤700	≤980
42213	113-204	205-482	≤779	≤1060	≤1459
42616	139-249	250-695	≤1125	≤1543	≤1999
43019	170-304	305-1015	≤1642	≤1999	
43622	222-399	400-1494	≤1999		
44229	169-389	390-1965	≤1999		
RS (ROUND-SLAB) CORES		PAGES 56 - 57			
41408		25-177	≤283	≤385	≤530
41811	25-39	40-270	≤400	≤525	≤800
42311	25-39	40-347	≤708	≤963	≤1325
42318	25-39	40-452	≤731	≤994	≤1378
42616	25-39	40-622	≤998	≤1369	≤1884
43019	25-62	63-918	≤1485	≤1999	
43622	40-62	63-1286	≤1999		
44229	40-62	63-1732	≤1999		

SIZE	GAP TO GAP ± 3%	UNGAPPED TO GAP COMBINATION			
		±3%	±5%	±7%	±10%
DS (DOUBLE SLAB) CORES		PAGES 56 - 57			
42311	109-195	196-386	≤625	≤850	≤1170
42318	78-135	136-441	≤706	≤961	≤1332
42616	117-205	206-580	≤930	≤1276	≤1756
43019	149-264	265-873	≤1412	≤1922	≤1999
43622	170-300	301-1111	≤1797	≤1999	
44229	179-315	316-1543	≤1999		
PQ CORES		PAGES 58 - 59			
42016	60-184	185-467	≤755	≤1027	≤1425
42020	50-139	140-467	≤754	≤1026	≤1422
42610	200-396	397-777	≤1258	≤1728	≤1999
42614	110-334	335-645	≤1044	≤1421	≤1972
42620	95-296	297-888	≤1436	≤1955	≤1999
42625	77-234	235-880	≤1423	≤1936	≤1999
43214	127-416	417-548	≤885	≤1207	≤1661
43220	128-409	410-486	≤1369	≤1878	≤1999
43230	84-241	242-808	≤1305	≤1775	≤1999
43535	89-255	256-980	≤1575	≤1999	
44040	83-230	231-1006	≤1625	≤1999	
45050	128-210	210-1999			
RM CORES		PAGES 60 - 61			
41110	25-50	51-55	≤75	≤170	≤250
41510	56-98	99-162	≤258	≤352	≤484
41812	69-120	121-238	≤381	≤519	≤714
41912	69-120	121-238	≤381	≤519	≤714
42316	84-150	151-395	≤633	≤862	≤1195
42819	126-200	201-625	≤1002	≤1374	≤1892
43723	145-250	251-977	≤1580	≤1999	

Chart shows type of combination and the guaranteed tolerance for corresponding A_L ranges. Ranges indicated are the tolerances for standard gaps. For ± 5%, ± 7%, and ± 10%, the maximum A_L for each is shown. Standard cores are manufactured to the smallest allowed tolerances. EE and EI tolerances are identical.

Toroids

2.54 mm – 12.7 mm

Ferrite toroids offer high magnetic efficiency as there is no air gap, and the cross sectional area is uniform. Available in many sizes (O.D. from 2.54 mm to 140 mm) and materials (permeabilities ranging from 750 to 15,000), this section lists common sizes.

Typical applications for high permeability toroids (J, W, and M materials) include common mode chokes, broadband transformers, pulse transformers and current transformers. L, R, P, F and T material toroids are excellent choices for high frequency transformers.

SIZE (mm)	ORDERING CODE	Y	Z	NOMINAL A_L (mH/1000T)									
				L ± 25%	R ± 25%	P ± 25%	F ± 20%	T ± 25%	J ± 20%	W ± 30%	M ± 30%	C ± 25%	
2.54 x 1.27 x 1.27	0_40200TC	✓			400	454	525			875	1,750		158
3.46 x 1.78 x 1.27	0_40301TC	✓			380	410	495			825	1,650		149
3.94 x 2.24 x 1.27	0_40502TC	✓			340	368	440			735	1,470	2,152	129
3.94 x 2.24 x 2.54	0_40503TC	✓			670	716	885			1,475	2,950		258
4.83 x 2.29 x 1.27	0_40401TC	✓			440	474	570			950	1,900		170
4.83 x 2.29 x 2.54	0_40402TC	✓			870	948	1,140			1,900	3,800		341
5.84 x 3.05 x 1.52	0_40601TC	✓		178	450	488	585	592		980	1,960	2,963	177
5.84 x 3.05 x 3.18	0_40603TC	✓		372	940	1,020	1,225			2,040	4,080	6,199	372
7.62 x 3.18 x 4.78	0_40705TC	✓		751	1,920	2,088	2,505			4,175	8,350	12,535	751
9.53 x 5.59 x 7.11	0_40907TC	✓	✓	683	1,730	1,884	2,260			3,765	7,530		683
9.53 x 4.75 x 3.18	0_41003TC	✓	✓	399	1,000	1,095	1,314	1,330		2,196	4,392	6,644	399
9.53 x 4.75 x 4.78	0_41005TC	✓	✓	599	1,510	1,650	1,980			3,308	6,616	9,988	599
12.7 x 5.16 x 6.35	0_41206TC	✓	✓	1,029	2,600	2,820	3,384			5,640	11,280	17,163	1,029
12.7 x 8.14 x 3.18	0_41303TC		✓	255	680	745	894			1,488	2,976		254
12.7 x 8.14 x 3.89	0_41304TC		✓	311	850	931	1,116			1,860	3,720		311
12.7 x 8.14 x 5.08	0_41305TC		✓	407	1,090	1,190	1,430			2,380	4,760		406
12.7 x 8.14 x 6.35	0_41306TC		✓	508	1,360	1,485	1,782	1,700		2,968	5,936	8,476	508

HOW TO ORDER

O J 4 14 06 TC

- Coating code ←
- Ferrite core material ←
- Used for all ferrite types ←
- Approximate diameter in mm ←
- Approximate height in mm ←
- Geometry code ←

Coating Code	Coating Material	Temperature Rating	Voltage Breakdown (wire to wire)
0	Bare Core	N/A	N/A
Y	Parylene	130°C	600V
Z	Epoxy	200°C	1000V

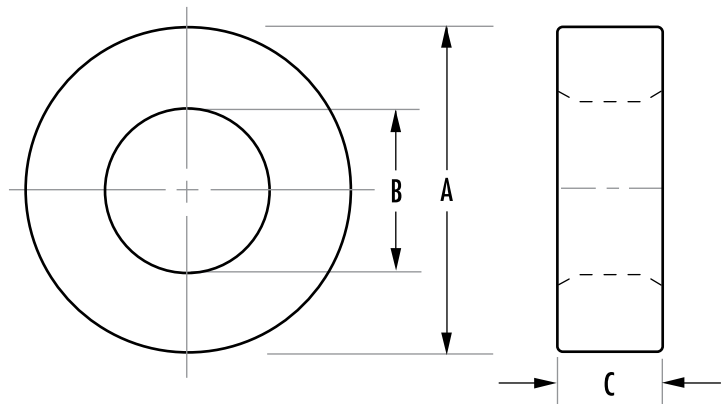



SIZE (mm)	ORDERING CODE	MAGNETIC DATA						HARDWARE
		I_e (mm)	A_e (mm ²)	V_e (mm ³)	Window Area (cm ²)	WaAc (cm ⁴)	Weight (grams per piece)	Headers & Mounts
2.54 x 1.27 x 1.27	O_40200TC	5.5	0.77	4.3	0.01	0.0001	0.03	SMH07058A
3.46 x 1.78 x 1.27	O_40301TC	7.65	1.03	7.87	0.02	0.0003	0.04	SMH07058A
3.94 x 2.24 x 1.27	O_40502TC	9.2	1.05	9.7	0.03	0.0004	0.05	SMH07058A
3.94 x 2.24 x 2.54	O_40503TC	9.2	2.1	19.4	0.03	0.0008	0.10	SMH07058A
4.83 x 2.29 x 1.27	O_40401TC	10.2	1.5	15.7	0.04	0.0006	0.09	SMH07058A
4.83 x 2.29 x 2.54	O_40402TC	10.2	3.1	31.5	0.04	0.001	0.17	SMH07058A
5.84 x 3.05 x 1.52	O_40601TC	13.0	2.0	26.7	0.07	0.001	0.14	SMH07058A
5.84 x 3.05 x 3.18	O_40603TC	13.0	4.3	56.0	0.07	0.003	0.30	SMH07058A
7.62 x 3.18 x 4.78	O_40705TC	15.0	9.9	149	0.07	0.008	0.90	SMH07058A
9.53 x 5.59 x 7.11	O_40907TC	22.7	13.7	310	0.24	0.03	1.60	
9.53 x 4.75 x 3.18	O_41003TC	20.7	7.3	151	0.17	0.01	0.82	
9.53 x 4.75 x 4.78	O_41005TC	20.7	10.9	227	0.17	0.02	1.20	
12.7 x 5.16 x 6.35	O_41206TC	25.0	22.0	550	0.20	0.05	3.30	
12.7 x 8.14 x 3.18	O_41303TC	31.7	7.1	226	0.49	0.04	1.20	
12.7 x 8.14 x 3.89	O_41304TC	31.7	8.7	276	0.49	0.05	1.44	
12.7 x 8.14 x 5.08	O_41305TC	31.7	11.4	361	0.49	0.06	1.90	
12.7 x 8.14 x 6.35	O_41306TC	31.7	14.2	451	0.49	0.07	2.40	

Refer to page 62 for additional hardware information.

SIZE (mm)	ORDERING CODE	BARE NOMINAL DIMENSIONS (mm)			Y/Z COATED LIMITING DIMENSIONS (mm)			
		OD (A)	ID (B)	HT (C)	COATING	OD max	ID min	HT max
2.54 x 1.27 x 1.27	O_40200TC	2.54	1.27	1.27	Y	2.79	1.02	1.52
3.46 x 1.78 x 1.27	O_40301TC	3.46	1.78	1.27	Y	3.79	1.54	1.53
3.94 x 2.24 x 1.27	O_40502TC	3.94	2.24	1.27	Y	4.22	1.95	1.53
3.94 x 2.24 x 2.54	O_40503TC	3.94	2.24	2.54	Y	4.22	1.95	2.87
4.83 x 2.29 x 1.27	O_40401TC	4.83	2.29	1.27	Y	5.11	2	1.53
4.83 x 2.29 x 2.54	O_40402TC	4.83	2.29	2.54	Y	5.11	2	2.87
5.84 x 3.05 x 1.52	O_40601TC	5.84	3.05	1.52	Y	6.2	2.69	1.78
5.84 x 3.05 x 3.18	O_40603TC	5.84	3.05	3.18	Y	6.2	2.69	3.51
7.62 x 3.18 x 4.78	O_40705TC	7.62	3.18	4.78	Y	7.95	2.84	4.98
9.53 x 5.59 x 7.11	O_40907TC	9.53	5.59	7.11	Z	10.17	4.95	7.66
9.53 x 4.75 x 3.18	O_41003TC	9.53	4.75	3.18	Z	10.17	4.2	3.73
9.53 x 4.75 x 4.78	O_41005TC	9.53	4.75	4.78	Z	10.17	4.2	5.33
12.7 x 5.16 x 6.35	O_41206TC	12.7	5.16	6.35	Z	13.34	4.52	6.91
12.7 x 8.14 x 3.18	O_41303TC	12.7	8.14	3.18	Z	13.34	7.29	3.69
12.7 x 8.14 x 3.89	O_41304TC	12.7	8.14	3.89	Z	13.34	7.29	4.47
12.7 x 8.14 x 5.08	O_41305TC	12.7	8.14	5.08	Z	13.34	7.29	5.75
12.7 x 8.14 x 6.35	O_41306TC	12.7	8.14	6.35	Z	13.34	7.29	6.91

W material and M material limit dimensions will vary, please refer to the specific part datasheet. For limiting dimensions of other available coatings, please refer to the specific part datasheet.

Toroids

12.7 mm – 25.34 mm



SIZE (mm)	ORDERING CODE	Y	Z	NOMINAL A_L (mH/1000T)								
				L ± 25%	R ± 25%	P ± 25%	F ± 20%	T ± 25%	J ± 20%	W ± 30%	M ± 30%	C ± 25%
12.7 x 7.14 x 5.08	0_41405TC		✓	526	1,320	1,440	1,730		2,890	5,780		500
12.7 x 7.14 x 6.35	0_41406TC		✓	658	1,660	1,805	2,166		3,612	7,224	10,974	625
12.7 x 7.14 x 4.78	0_41407TC		✓	495	1,240	1,356	1,630		2,715	5,430		470
12.7 x 7.14 x 7.62	0_41410TC		✓	790	1,990	2,162	2,595		4,335	8,675		790
13.2 x 7.37 x 3.96	0_41506TC		✓	415	1,020	1,111	1,334	1,320	2,295	4,590		315
13.6 x 7.01 x 3.51	0_41435TC		✓	419	1,040	1,130	1,350		2,260	4,520		418
14.0 x 8.99 x 5.0	0_41450TC		✓	399	990	1,080	1,290		2,160	4,320		397
15.9 x 9.07 x 4.7	0_41605TC		✓	475	1,260	1,375	1,650	1,580	2,760	5,520	7,917	475
15.9 x 9.07 x 5.7	0_41606TC		✓				1,920					
15.9 x 9.07 x 6.84	0_41607TC		✓				2,300					
15.9 x 9.07 x 9.4	0_41610TC		✓	950	2,450	2,660	3,200		5,410	10,600		950
18.4 x 9.75 x 10.3	0_41809TC		✓	1,177	2,810	3,050	3,660		6,115	12,200		1,177
20.6 x 12.7 x 6.35	0_42106TC		✓	553	1,380	1,500	1,680		2,800	5,600		553
20.6 x 12.7 x 8.89	0_42109TC		✓	774	1,930	2,100	2,520		4,200	8,400		774
22.1 x 13.7 x 6.35	0_42206TC		✓	547	1,380	1,510	1,812	1,790	3,020	6,040	8,494	538
22.1 x 13.7 x 7.9	0_42207TC		✓	680	1,720	1,875	2,250		3,700	7,400		671
22.1 x 13.7 x 12.7	0_42212TC		✓	1,093	2,770	3,020	3,624		6,040	12,080	17,313	1,084
25.34 x 12.7 x 9.53	0_42506TC		✓				3,627					
25.34 x 15.45 x 7.66	0_42507TC		✓	705	1,800	1,958	2,348		3,913	7,825	11,072	690
25.34 x 15.45 x 10.0	0_42508TC		✓	891	2,220	2,420	2,900		4,830	9,660		

HOW TO ORDER

O J 4 14 06 TC

Coating code

Ferrite core material

Used for all ferrite types

Approximate diameter in mm

Approximate height in mm

Geometry code

Coating Code	Coating Material	Temperature Rating	Voltage Breakdown (wire to wire)
O	Bare Core	N/A	N/A
Y	Parylene	130°C	600V
Z	Epoxy	200°C	1000V

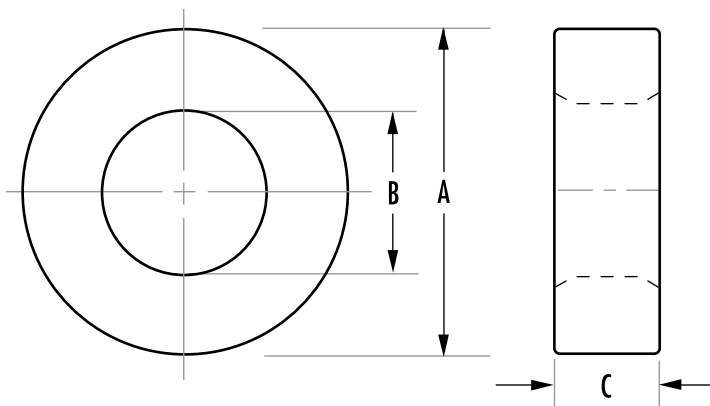



Refer to page 62 for additional hardware information.

SIZE (mm)	ORDERING CODE	MAGNETIC DATA						HARDWARE
		I _e (mm)	A _e (mm ²)	V _e (mm ³)	Window Area (cm ²)	WaAc (cm ⁴)	Weight (grams/pc)	Headers & Mounts
12.7 x 7.14 x 5.08	0_41405TC	29.5	13.7	405	0.40	0.05	2.03	
12.7 x 7.14 x 6.35	0_41406TC	29.5	17.1	507	0.40	0.07	2.70	TVB22066A
12.7 x 7.14 x 4.78	0_41407TC	29.5	12.9	381	0.40	0.05	1.90	TVB22066A
12.7 x 7.14 x 7.62	0_41410TC	29.5	20.6	608	0.40	0.17	3.04	
13.2 x 7.37 x 3.96	0_41506TC	30.6	11.2	343	0.42	0.05	1.9	TVB22066A
13.6 x 7.01 x 3.51	0_41435TC	30.1	11.1	335	0.36	0.04	1.7	
14.0 x 8.99 x 5.0	0_41450TC	35.0	12.3	430	0.63	0.08	2.2	TVB22066A
15.9 x 9.07 x 4.7	0_41605TC	37.2	15.6	580	0.62	0.10	2.8	TVB22066A
15.9 x 9.07 x 5.7	0_41606TC	37.2	19.0	706	0.62	0.13	4.1	TVB22066A
15.9 x 9.07 x 6.84	0_41607TC	37.2	22.8	847	0.64	0.15	4.5	TVB22066A
15.9 x 9.07 x 9.4	0_41610TC	37.2	31.2	1,164	0.62	0.20	5.8	
18.4 x 9.75 x 10.3	0_41809TC	41.4	43.1	1,783	0.74	0.32	9.9	TVB22066A
20.6 x 12.7 x 6.35	0_42106TC	50.3	24.6	1,238	1.27	0.31	5.4	TVB22066A
20.6 x 12.7 x 8.89	0_42109TC	50.3	34.4	1,733	1.27	0.43	8.1	TVB22066A
22.1 x 13.7 x 6.35	0_42206TC	54.1	26.2	1,417	1.48	0.39	6.4	TVB22066A
22.1 x 13.7 x 7.9	0_42207TC	54.2	32.5	1,763	1.48	0.48	8.5	TVB22066A
22.1 x 13.7 x 12.7	0_42212TC	51.9	52.3	2,834	1.48	0.77	13.5	TVB22066A
25.34 x 12.7 x 9.53	0_42506TC	55.3	57.9	3,199	1.26	0.73	25.0	TVH25074A
25.34 x 15.45 x 7.66	0_42507TC	61.5	37.1	2,284	1.89	0.69	11.6	TVH25074A
25.34 x 15.45 x 10.0	0_42508TC	61.5	48.0	2,981	1.89	0.89	14.9	TVH25074A

SIZE (mm)	ORDERING CODE	BARE NOMINAL DIMENSIONS (mm)			Z-COATED LIMITING DIMENSIONS (mm)		
		OD (A)	ID (B)	HT (C)	OD max	ID min	HT max
12.7 x 7.14 x 5.08	0_41405TC	12.7	7.14	5.08	13.34	6.5	5.75
12.7 x 7.14 x 6.35	0_41406TC	12.7	7.14	6.35	13.34	6.5	6.91
12.7 x 7.14 x 4.78	0_41407TC	12.7	7.14	4.78	13.34	6.5	5.29
12.7 x 7.14 x 7.62	0_41410TC	12.7	7.14	7.62	13.34	6.5	8.26
13.2 x 7.37 x 3.96	0_41506TC	13.2	7.37	3.96	13.84	6.73	4.47
13.6 x 7.01 x 3.51	0_41435TC	13.6	7.01	3.51	14.23	6.37	4.02
14.0 x 8.99 x 5.0	0_41450TC	14.0	8.99	5.0	14.64	8.35	5.52
15.9 x 9.07 x 4.7	0_41605TC	15.9	9.07	4.7	16.64	8.12	5.21
15.9 x 9.07 x 5.7	0_41606TC	15.9	9.07	5.7	16.59	7.92	6.4
15.9 x 9.07 x 6.84	0_41607TC	15.9	9.07	6.84	16.64	8.12	7.51
15.9 x 9.07 x 9.4	0_41610TC	15.9	9.07	9.4	16.64	8.12	10.03
18.4 x 9.75 x 10.3	0_41809TC	18.4	9.75	10.3	19.21	8.99	10.9
20.6 x 12.7 x 6.35	0_42106TC	20.6	12.7	6.35	21.34	11.93	6.91
20.6 x 12.7 x 8.89	0_42109TC	20.6	12.7	8.89	21.34	11.93	9.53
22.1 x 13.7 x 6.35	0_42206TC	22.1	13.7	6.35	22.86	12.95	6.91
22.1 x 13.7 x 7.9	0_42207TC	22.1	13.7	7.9	22.86	12.95	8.56
22.1 x 13.7 x 12.7	0_42212TC	22.1	13.7	12.7	22.86	12.95	13.34
25.34 x 12.7 x 9.53	0_42506TC	25.34	12.7	9.53	26.29	12.83	10.16
25.34 x 15.45 x 7.66	0_42507TC	25.34	15.45	7.66	26.29	14.6	8.56
25.34 x 15.45 x 10.0	0_42508TC	25.34	15.45	10.0	26.29	14.6	10.65



W material and M material limit dimensions will vary, please refer to the specific part datasheet. For limiting dimensions of other available coatings, please refer to the specific part datasheet.

Toroids

26.9 mm – 46.9 mm



SIZE (mm)	ORDERING CODE	Y	Z	NOMINAL A_L (mH/1000T)					
				R \pm 25%	P \pm 25%	F \pm 20%	T \pm 25%	J \pm 20%	W \pm 30%
26.9 x 14.2 x 12.2	0_42712TC		✓	3,610	3,920	4,710		7,650	15,300
29 x 19 x 7.43	0_42908TC		✓	1,450	1,585	1,902		3,170	6,340
29 x 19 x 15.2	0_42915TC		✓	2,960	3,222	3,868		6,447	12,894
30.8 x 19.1 x 12.7	0_43113TC		✓	2,850	3,100	3,720		6,200	12,400
32 x 15 x 4.5	0_43205TC		✓	1,480	1,610	1,930		3,220	6,440
36 x 23 x 10	0_43610TC		✓	2,030	2,210	2,726		4,543	9,085
36 x 23 x 15	0_43615TC		✓	3,100	3,366	4,040		6,736	13,400
36 x 23 x 20	0_43620TC		✓					9,086	
38.1 x 19 x 6.35	0_43806TC		✓	2,020	2,200	2,640		4,400	8,800
38.1 x 19 x 12.7	0_43813TC		✓	3,850	4,185	5,020	5,190	8,365	16,700
38.1 x 19 x 25.4	0_43825TC		✓	8,060	8,762	10,040		16,730	33,400
41.8 x 26.2 x 18	0_44015TC		✓	3,860	4,200	5,040	5,040	8,408	16,816
44.3 x 19 x 15.9	0_44416TC		✓	5,360	5,830	7,000		11,600	23,200
44.3 x 19 x 19.1	0_44419TC		✓		7,970	9,550			
46.9 x 27 x 15	0_44715TC		✓	3,700	4,030	4,840		8,075	16,100

HOW TO ORDER

O J 4 14 06 TC

- Coating code ← O
- Ferrite core material ← J
- Used for all ferrite types ← 4
- Approximate diameter in mm ← 14
- Approximate height in mm ← 06
- Geometry code ← TC

Coating Code	Coating Material	Temperature Rating	Voltage Breakdown (wire to wire)
O	Bare Core	N/A	N/A
Y	Parylene	130°C	600V
Z	Epoxy	200°C	1000V

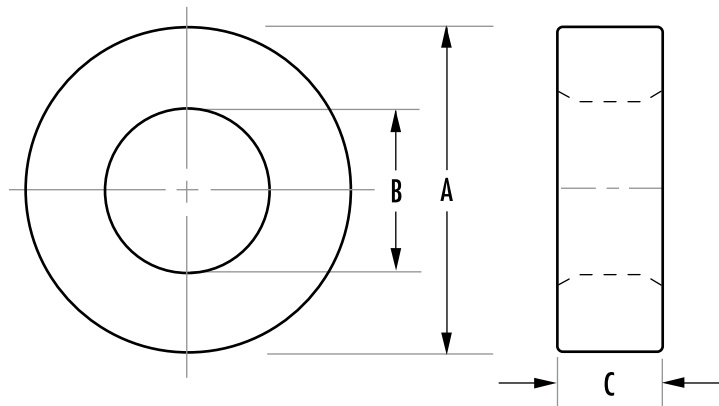



SIZE (mm)	ORDERING CODE	MAGNETIC DATA						HARDWARE
		I _e (mm)	A _e (mm ²)	V _e (mm ³)	Window Area (cm ²)	WaAc (cm ⁴)	Weight (grams per piece)	Headers & Mounts
26.9 x 14.2 x 12.2	0_42712TC	60.2	73.2	4,410	1.57	1.16	22.5	
29 x 19 x 7.43	0_42908TC	73.2	37.0	2,679	2.84	1.05	12.9	TVH25074A
29 x 19 x 15.2	0_42915TC	73.2	74.9	5,481	2.84	2.13	27.6	TVH25074A
30.8 x 19.1 x 12.7	0_43113TC	75.4	73.6	5,547	2.83	2.11	29.3	TVB2908TA
32 x 15 x 4.5	0_43205TC	67.2	36.4	2,451	0.34	0.61	12.9	TVH38134A
36 x 23 x 10	0_43610TC	89.7	63.9	5,731	4.15	2.65	29.4	TVH38134A
36 x 23 x 15	0_43615TC	89.6	95.9	8,596	2.85	3.98	44	TVH38134A
36 x 23 x 20	0_43620TC	89.6	128	11,461	4.15	5.31	54	
38.1 x 19 x 6.35	0_43806TC	82.9	58.3	4,826	2.85	1.66	26.4	TVH38134A
38.1 x 19 x 12.7	0_43813TC	82.9	115.6	9,652	2.85	3.28	51.7	TVH38134A
38.1 x 19 x 25.4	0_43825TC	82.8	233	19,304	2.85	6.56	103.4	TVH38134A
41.8 x 26.2 x 18	0_44015TC	103	138	14,205	5.39	7.44	68.9	TVH49164A
44.3 x 19 x 15.9	0_44416TC	88.0	187	16,559	2.85	5.33	80.8	TVH49164A
44.3 x 19 x 19.1	0_44419TC	88.0	228	20,146	2.85	6.50	107.9	
46.9 x 27 x 15	0_44715TC	110.4	145.5	16,063	5.72	8.34	84.0	TVH49164A

Refer to page 62 for additional hardware information.

SIZE (mm)	ORDERING CODE	BARE NOMINAL DIMENSIONS (mm)			Z-COATED LIMITING DIMENSIONS (mm)		
		OD (A)	ID (B)	HT (C)	OD max	ID min	HT max
26.9 x 14.2 x 12.2	0_42712TC	26.9	14.2	12.2	28.01	13.01	13
29 x 19 x 7.43	0_42908TC	29.0	19.0	7.43	29.9	18.11	8.06
29 x 19 x 15.2	0_42915TC	29.0	19.0	15.2	30.15	17.85	16.21
30.8 x 19.1 x 12.7	0_43113TC	30.8	19.1	12.7	31.88	18.11	13.64
32 x 15 x 4.5	0_43205TC	32.0	15.0	4.5	32.9	14.12	5.01
36 x 23 x 10	0_43610TC	36.0	23.0	10.0	37.15	22.05	10.65
36 x 23 x 15	0_43615TC	36.0	23.0	15.0	37.15	22.05	15.6
36 x 23 x 20	0_43620TC	36.0	23.0	20.0	37.15	22.05	20.65
38.1 x 19 x 6.35	0_43806TC	38.1	19.0	6.35	39.25	17.9	6.91
38.1 x 19 x 12.7	0_43813TC	38.1	19.0	12.7	39.25	17.9	13.34
38.1 x 19 x 25.4	0_43825TC	38.1	19.0	25.4	39.25	17.9	26.29
41.8 x 26.2 x 18	0_44015TC	41.8	26.2	18.0	43.15	25.15	19.2
44.3 x 19 x 15.9	0_44416TC	44.3	19.0	15.7	45.6	17.9	16.64
44.3 x 19 x 19.1	0_44419TC	44.3	19.0	19.1	45.6	17.9	20.14
46.9 x 27 x 15	0_44715TC	46.9	27.0	15.0	48.04	25.85	15.65

W-perm limiting dimensions will vary, please refer to the specific part datasheet. For limiting dimensions of other available coatings, please refer to the specific part datasheet.

Toroids

49.1 mm – 140 mm



SIZE (mm)	ORDERING CODE	Y	Z	NOMINAL A_L (mH/1000T)					
				R \pm 25%	P \pm 25%	F \pm 20%	T \pm 25%	J \pm 20%	W \pm 30%
49.1 x 33.8 x 15.9	0_44916TC		✓	2,710	2,950	3,540		5,900	11,800
49.1 x 31.8 x 15.9	0_44920TC		✓	2,790	3,032	3,640		6,065	12,130
49.1 x 31.8 x 19.05	0_44925TC		✓	3,420	3,718	4,460		7,435	14,870
49.1 x 33.8 x 31.3	0_44932TC		✓	5,430	5,900	7,080		11,800	23,600
60.96 x 41.78 x 12.7	0_46013TC		✓		1,960			4,800	9,483
60.96 x 41.78 x 19.05	0_46019TC		✓					7,100	
61 x 35.6 x 12.7	0_46113TC		✓	3,140	3,491	4,107		6,845	13,690
63 x 38 x 24.5	0_46325TC		✓						21,056
63 x 38 x 24.5	0_46326TC		✓	5,770	6,270	7,530		12,500	
73.7 x 38.9 x 12.5	0_47313TC		✓	3,700	4,024	4,880	5,790	8,140	16,280
73.7 x 38.9 x 25.2	0_47325TC		✓	7,400	8,050	9,760		16,280	
73.7 x 38.9 x 25.4	0_47326TC		✓						27,610
85.7 x 55.5 x 12.7	0_48613TC		✓	2,510	2,726	3,310		5,520	11,040
85.7 x 55.5 x 19.05	0_48619TC		✓						14,900
85.7 x 55.5 x 25.4	0_48625TC		✓	5,040	5,480	6,570		10,960	
85.7 x 55.5 x 25.4	0_48626TC		✓						18,760
102 x 65.8 x 15	0_49715TC		✓	3,025	3,464	3,945		6,575	11,178
107 x 65 x 18	0_49718TC		✓	4,127	4,486	5,383		8,972	15,252
107 x 65 x 25	0_49725TC		✓	5,732	6,230	7,477		12,461	21,184
140 x 106 x 25	0_49740TC		✓	3,200	3,477	4,173		6,955	11,823

HOW TO ORDER

O J 4 14 06 TC

Coating code ←
 Ferrite core material ←
 Used for all ferrite types ←
 Approximate diameter in mm ←
 Approximate height in mm ←
 Geometry code ←

Coating Code	Coating Material	Temperature Rating	Voltage Breakdown (wire to wire)
0	Bare Core	N/A	N/A
Y	Parylene	130°C	600V
Z	Epoxy	200°C	1000V

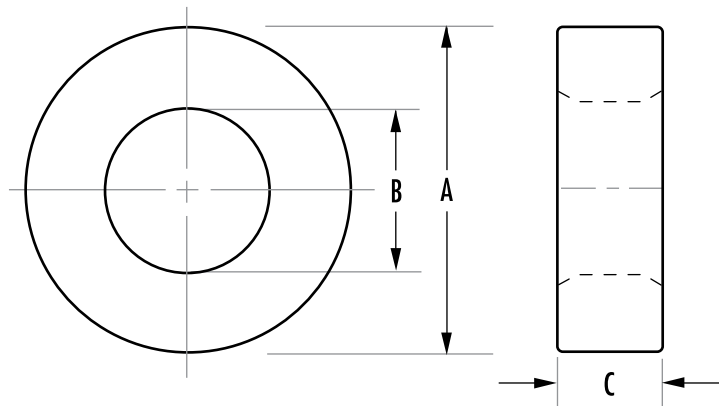



Refer to page 62 for additional hardware information.

SIZE (mm)	ORDERING CODE	MAGNETIC DATA						HARDWARE
		I _e (mm)	A _e (mm ²)	V _e (mm ³)	Window Area (cm ²)	WaAc (cm ⁴)	Weight (grams/pc)	Headers & Mounts
49.1 x 33.8 x 15.9	0_44916TC	127	120	15,298	8.99	10.6	75.3	TVH49164A
49.1 x 31.8 x 15.9	0_44920TC	123.2	135.4	16,676	7.94	9.45	83	TVH49164A
49.1 x 31.8 x 19.05	0_44925TC	123	162	20,000	7.94	12.8	98	TVH49164A
49.1 x 33.8 x 31.3	0_44932TC	127	237	30,100	8.99	21.2	150.6	TVH49164A
60.96 x 41.78 x 12.7	0_46013TC	157.6	120.4	18,968	13.68	16.48	94	
60.96 x 41.78 x 19.05	0_46019TC	157.6	180.5	28,453	13.68	24.7	141	
61 x 35.6 x 12.7	0_46113TC	144.6	157.4	22,774	9.93	15.5	113	TVH49164A
63 x 38 x 24.5	0_46325TC	152	300	45,598	11.1	33.2	225	TVH49164A
63 x 38 x 24.5	0_46326TC	152	300	45,600	11.3	33.9	225	TVH49164A
73.7 x 38.9 x 12.5	0_47313TC	165	210	34,771	11.9	25	172	
73.7 x 38.9 x 25.2	0_47325TC	165	423	70,099	11.9	50.3	347	
73.7 x 38.9 x 25.4	0_47326TC	165	427	70,595	11.9	50.8	350	
85.7 x 55.5 x 12.7	0_48613TC	214.9	188.8	40,582	24.2	45.7	201	
85.7 x 55.5 x 19.05	0_48619TC	215	283	60,874	24.2	68.4	302	
85.7 x 55.5 x 25.4	0_48625TC	215	375	80,700	24.2	90.8	399	
85.7 x 55.5 x 25.4	0_48626TC	215	377	81,165	24.2	91.2	402	
102 x 65.8 x 15	0_49715TC	255.3	267.2	68,821	34	90.8	341	
107 x 65 x 18	0_49718TC	259.31	370.27	96,013	28.6	106	475	
107 x 65 x 25	0_49725TC	259.31	514.3	133,351	33.2	171	660	
140 x 106 x 25	0_49740TC	381.5	422.3	161,086	88.2	372	797	

SIZE (mm)	ORDERING CODE	BARE NOMINAL DIMENSIONS (mm)			Z-COATED LIMITING DIMENSIONS (mm)		
		OD (A)	ID (B)	HT (C)	OD max	ID min	Ht. max
49.1 x 33.8 x 15.9	0_44916TC	49.1	33.8	15.9	50.22	32.69	16.64
49.1 x 31.8 x 15.9	0_44920TC	49.1	31.8	15.9	50.22	30.65	16.64
49.1 x 31.8 x 19.05	0_44925TC	49.1	31.8	19.05	50.22	30.65	19.82
49.1 x 33.8 x 31.3	0_44932TC	49.1	33.8	31.3	50.22	32.69	32.64
60.96 x 41.78 x 12.7	0_46013TC	60.96	41.78	12.7	62.23	40.51	13.34
60.96 x 41.78 x 19.05	0_46019TC	60.96	41.78	19.05	62.23	40.51	19.95
61 x 35.6 x 12.7	0_46113TC	61	35.6	12.7	62.23	34.29	13.34
63 x 38 x 24.5	0_46325TC	63	38	24.5	64.9	35.97	25.96
63 x 38 x 24.5	0_46326TC	63	38	24.5	64.9	36.4	25.8
73.7 x 38.9 x 12.5	0_47313TC	73.7	38.9	12.5	75.06	37.46	13.34
73.7 x 38.9 x 25.2	0_47325TC	73.7	38.9	25.2	75.06	37.46	26.29
73.7 x 38.9 x 25.4	0_47326TC	73.7	38.9	25.4	75.56	36.96	26.92
85.7 x 55.5 x 12.7	0_48613TC	85.7	55.5	12.7	87.38	53.89	13.34
85.7 x 55.5 x 19.05	0_48619TC	85.7	55.5	19.05	88.02	53.26	20.97
85.7 x 55.5 x 25.4	0_48625TC	85.7	55.5	25.4	87.38	53.89	26.65
85.7 x 55.5 x 25.4	0_48626TC	85.7	55.5	25.4	88.02	53.26	26.92
102 x 65.8 x 15	0_49715TC	102	65.8	15	104.5	64.1	16
107 x 65 x 18	0_49718TC	107	65	18	109.5	63.3	18.85
107 x 65 x 25	0_49725TC	107	65	25	109.5	63.3	26.05
140 x 106 x 25	0_49740TC	140	106	25	143.5	103.6	26.4

E, I Cores

9 mm – 35 mm

E cores are less expensive than pot cores and have the advantage of simple bobbin winding plus easy assembly. E cores do not, however, offer self-shielding. Lamination size E cores are available to fit commercially offered bobbins previously designed to fit the strip stampings of standard lamination sizes. Metric and DIN sizes are also available. E cores can be pressed to different thicknesses, providing a selection of cross-sectional areas. E cores can be mounted in different directions and, if desired, provide a low profile.

Typical applications for E cores include differential mode, power and telecom inductors, as well as broadband, power, converter and inverter transformers.

TYPE/SIZE	ORDERING CODE	NOMINAL A_L (mH/1000T)						
		L	R	P	F	T	J	W
E 9/4/2	0_40904EC	280	493	540	650		1,040	
E 13/7/3	0_41203EC	350	587	640	770		1,367	
E 13/7/6	0_41205EC	700	1,467	1,600	1,950		3,300	
E 17/7/4	0_41707EC	520	1,013	1,100	1,300		1,900	
E 19/8/5	0_41808EC	550	1,153	1,253	1,500	1,500	2,500	4,293
E 19/8/10	0_41810EC	1,000	2,300	2,500	3,000		5,000	8,600
E 25/10/7	0_42510EC	800	1,767	1,920	2,300		3,700	7,660
E 25/13/7	0_42513EC	900	1,900	2,314	2,460		4,000	
E 25/16/6	0_42515EC	540	1,153	1,253	1,500		2,400	
E 25/10/13	0_42520EC	1,600	3,533	3,840	4,600		7,400	13,813
E 25/13/11	0_42526EC		2,800	3,512	4,068	4,068	5,951	
E 25/16/13	0_42530EC	1,070	2,307	2,507	3,000		4,800	8,213
E 31/15/7	0_43007EC	920	2,060	2,240	2,700		3,800	8,200
E 31/13/9	0_43009EC	1,400	2,893	3,147	3,780		5,893	
E 34/14/9	0_43515EC		2,667	2,907	3,500		5,813	11,414
E 35/21/9	0_43520EC		1,947	2,120	2,555		4,240	

HOW TO ORDER

OR 43007 EC

Shape code ←

Ferrite core material ←

Used for all ferrite types ←

Approximate length in mm ←

Approximate height in mm ←

Geometry code ←

GEOMETRY CODE

EC – E core

IC – I core

Cores are sold per piece (for sets multiply by 2).

See page 18 for information on gapped cores.

For an E-core gapped to an A_L value when mated with the standard I-core, add “-EI” to the end of the part number.

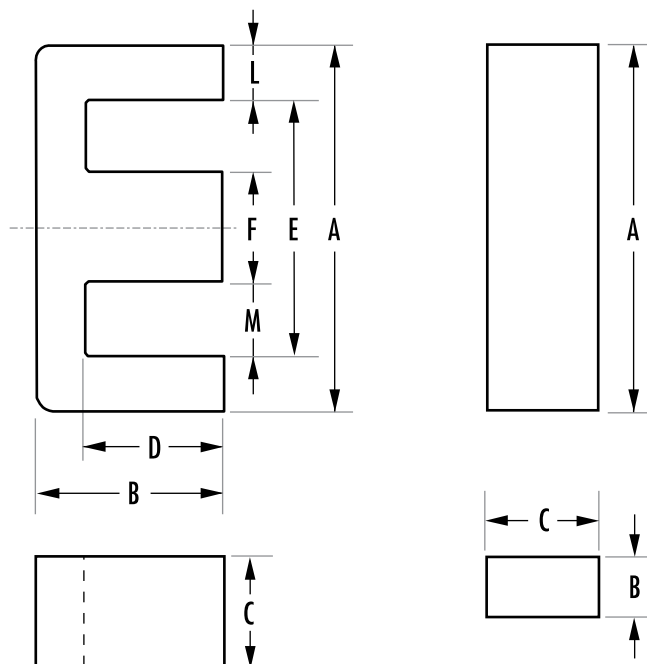

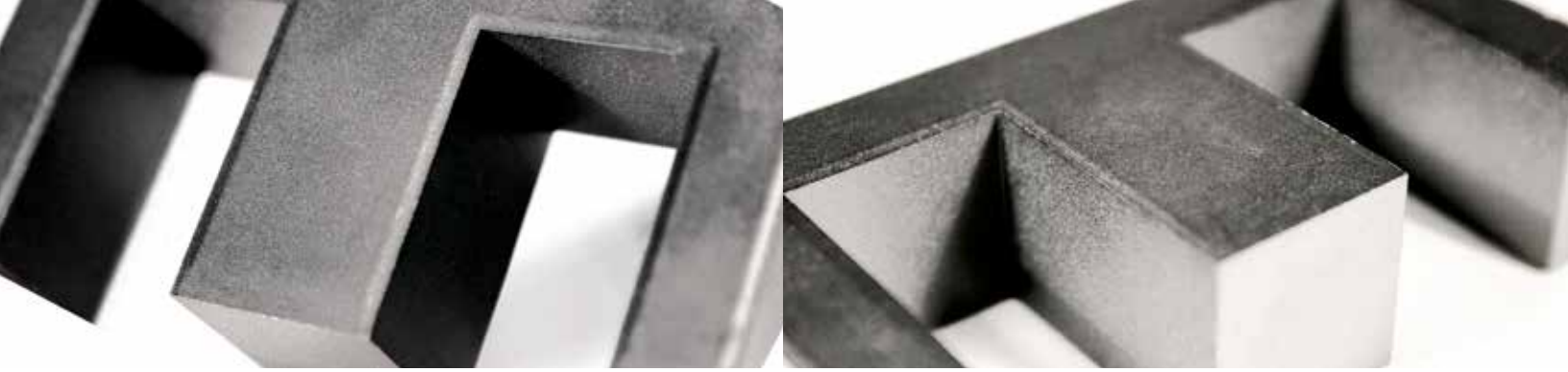

TYPE/SIZE	ORDERING CODE	MAGNETIC DATA						HARDWARE
		I _e (mm)	A _e (mm ²)	A _e min (mm ²)	V _e (mm ³)	WaAc (cm ⁴)	Weight (grams per set)	Bobbins
E 9/4/2	O_40904EC	15.6	5.0	3.6	78	0.002	0.7	
E 13/7/3	O_41203EC	27.8	10.1	10.1	279	0.016	1.3	
E 13/7/6	O_41205EC	27.7	20.2	20.0	558	0.03	2.6	
E 17/7/4	O_41707EC	30.4	16.6	12.6	505	0.03	3.0	
E 19/8/5	O_41808EC	39.9	22.6	22.1	900	0.08	4.4	PCB1808B1
E 19/8/10	O_41810EC	40.1	45.5	45.4	1,820	0.14	8.5	
E 25/10/7	O_42510EC	49.0	39.5	37.0	1,930	0.16	9.5	O0B251001
E 25/13/7	O_42513EC	57.8	51.8	51.8	2,990	0.27	16	
E 25/16/6	O_42515EC	73.5	40.1	39.7	2,950	0.56	15	O0B251501
E 25/10/13	O_42520EC	48.0	78.4	76.8	3,760	0.48	19	PCB2520TA
E 25/13/11	O_42526EC	57.5	78.4	76.8	4,500	0.41	36	
E 25/16/13	O_42530EC	73.5	80.2	79.4	5,900	0.74	30	
E 31/15/7	O_43007EC	67.0	60.0	49.0	4,000	0.50	20	
E 31/13/9	O_43009EC	61.9	83.2	83.2	5,150	0.59	26	PCB3009LA
E 34/14/9	O_43515EC	69.3	80.7	80.7	5,590	0.98	28	PCB3515M1
E 35/21/9	O_43520EC	94.3	90.6	90.5	8,540	1.68	42	

Refer to page 62 for additional hardware information.

TYPE/SIZE	ORDERING CODE	DIMENSIONS (mm)							
		A	B	C	D	E	F	L	M
E 9/4/2	O_40904EC	9.0±0.4	4.06±0.25	1.91±0.13	2.03 min	4.85 min	1.91±0.13	1.91±0.25	1.57±0.25
E 13/7/3	O_41203EC	12.7±0.25	5.69±0.18	3.18±0.13	3.96 min	9.19 min	3.18±0.08	1.57 nom	3.05 min
E 13/7/6	O_41205EC	12.7±0.25	5.69±0.18	6.4±0.15	3.96 min	9.2 min	3.2±0.13	1.57 ref	3.05 min
E 17/7/4	O_41707EC	16.8±0.38	7.11±0.18	3.56±0.12	3.94 min	10.4 min	3.56±0.13	2.79 nom	3.63 min
E 19/8/5	O_41808EC	19.1±0.4	8.1±0.13	4.75±0.2	5.7±0.13	14.33±0.33	4.75±0.2	2.38 nom	4.79 nom
E 19/8/10	O_41810EC	19.1±0.4	8.1±0.18	9.53±0.13	5.7 min	14.0 min	4.75±0.2	2.38 ref	4.79 ref
E 25/10/7	O_42510EC	25.4±0.6	9.65±0.2	6.35±0.25	6.4 min	18.8 min	6.35±0.25	3.3 nom	6.1 min
E 25/13/7	O_42513EC	25.0+0.8/-0.7	12.8+0/-0.4	7.5+0/-0.6	8.7+0.6/-0	17.5+0.9/-0	7.5+0/-0.5	3.55 ref	5.35 ref
E 25/16/6	O_42515EC	25.4±0.38	15.9±0.25	6.35±0.25	12.6 min	18.8 min	6.35±0.13	3.12±0.13	6.4±0.25
E 25/10/13	O_42520EC	25.4±0.6	9.65±0.2	12.7±0.25	6.4 min	18.8 min	6.35±0.25	3.6 max	6.1 min
E 25/13/11	O_42526EC	25.0+0.8/-0.7	12.8+0/-0.5	11+0/-0.5	8.7+0.5/-0	17.5+1/-0	7.5+0/-0.5	3.53 ref	5.37 ref
E 25/16/13	O_42530EC	25.4±0.38	15.9±0.25	12.7±0.25	12.6 min	18.8 min	6.35±0.13	3.12±0.13	6.4±0.25
E 31/15/7	O_43007EC	30.8+0/-1.4	15.0±0.2	7.3±0/-0.5	9.71+0.5/-0	19.5+1/-0	7.2+0/-0.5	5.65 nom	6.15 nom
E 31/13/9	O_43009EC	30.95±0.5	13.1±0.25	9.4±0.3	8.5 min	21.4 min	9.4±0.13	4.29 nom	6.0 min
E 34/14/9	O_43515EC	34.3±0.6	14.1±0.15	9.3±0.25	9.8±0.13	25.5 min	9.3±0.2	4.7 max	8.0 min
E 35/21/9	O_43520EC	34.9±0.38	20.6±0.25	9.53±0.18	15.6 min	25.1 min	9.53±0.25	4.75±0.25	7.95 nom

E, I Cores

40 mm – 100 mm



TYPE/SIZE	ORDERING CODE	NOMINAL A_L (mH/1000T)					
		R	P	F	T	J	W
E 40/17/11	O_44011EC	4,000	4,347	5,200		7,293	
E 42/21/9	O_44016EC	2,667	2,907	3,495		5,647	
E 43/21/15	O_44020EC	4,600	5,000	6,000	5,300	9,700	
I 43/6/15	O_44020IC	6,253	6,800				
E 43/21/20	O_44022EC	5,533	6,013	7,600	6,950	10,613	
E 42/33/20	O_44033EC	4,000	4,709	5,562		8,727	
E 41/17/12	O_44317EC	3,900	4,240	5,900		9,800	18,293
E 47/20/16	O_44721EC	5,360	5,827	8,300			
E 56/28/21	O_45528EC	6,293	6,840	8,220	8,625		
E 56/28/25	O_45530EC	7,520	8,173	9,800	9,860	14,920	
E 56/24/19	O_45724EC	8,093	8,800	10,400	10,440	14,580	24,000
E 60/22/16	O_46016EC	5,733	6,240	6,590			
E 60/31/22	O_46022EC	7,500					
E 65/32/27	O_46527EC	8,600	9,200		10,600		
E 70/33/32	O_47133EC	10,800	11,600	13,400	13,330		
E 72/28/19	O_47228EC	5,960	6,480	7,780	7,780	11,850	
E 80/38/20	O_48020EC	4,673	5,080	6,000	6,730		
E 100/59/27	O_49928EC	6,227	6,773		9,010		

HOW TO ORDER

O R 4 7 2 2 8 E C

- Shape code ←
- Ferrite core material ←
- Used for all ferrite types ←
- Approximate length in mm ←
- Approximate height in mm ←
- Geometry code ←

GEOMETRY CODE

EC – E core
IC – I core

Cores are sold per piece (for sets multiply by 2).
See page 18 for information on gapped cores.

For an E-core gapped to an A_L value when mated with the standard I-core, add “-EI” to the end of the part number.

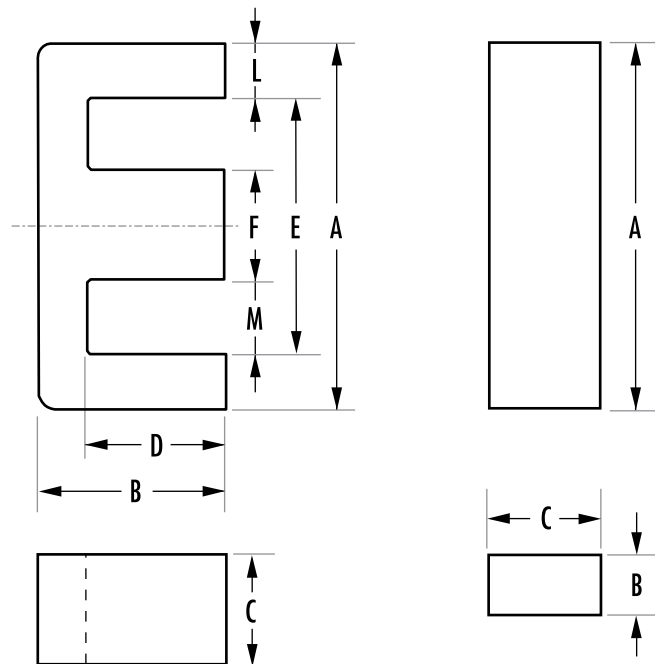

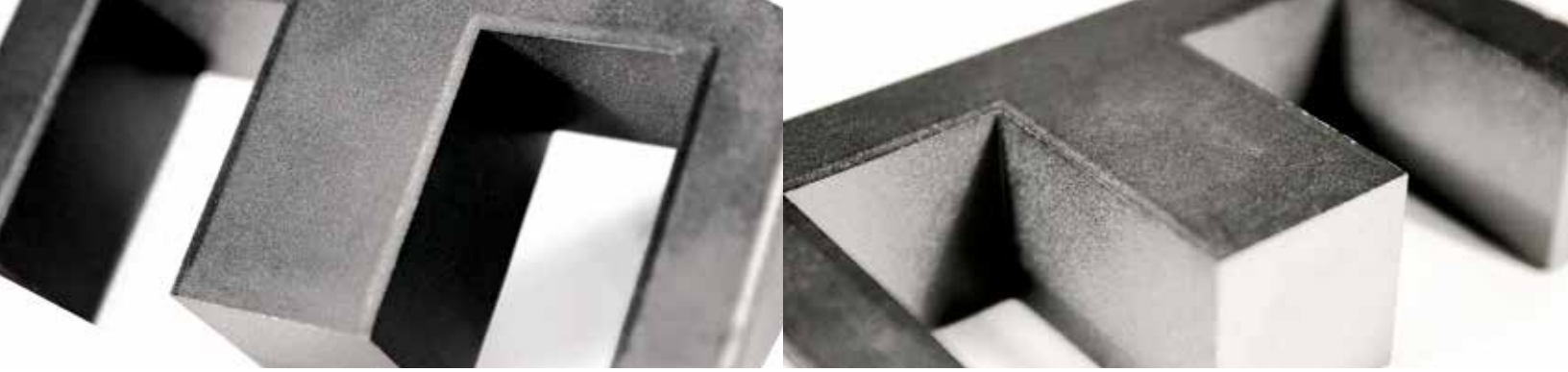

TYPE/SIZE	ORDERING CODE	MAGNETIC DATA						HARDWARE
		I_e (mm)	A_e (mm ²)	A_e min (mm ²)	V_e (mm ³)	$WaAc$ (cm ⁴)	Weight (grams per set)	Bobbins
E 40/17/11	O_44011EC	76.7	127	114	9,780	1.26	49	
E 42/21/9	O_44016EC	98.4	107	106	10,500	1.65	52	
E 43/21/15	O_44020EC	97.0	178	175	17,300	3.55	87	PCB4020N1
I 43/6/15	O_44020IC	67.1	177	176	11,900	1.36	60	PCB4020N1
E 43/21/20	O_44022EC	97.0	233	233	22,700	4.22	114	PCB4022N1
E 42/33/20	O_44033EC	145	236	234	34,200	6.36	164	
E 41/17/12	O_44317EC	77.0	149	142	11,500	1.88	57	PCB4317M1
E 47/20/16	O_44721EC	88.9	234	226	20,800	3.3	103	PCB4721M1
E 56/28/21	O_45528EC	124	353	345	44,000	9.78	212	PCB5528WC
E 56/28/25	O_45530EC	123	420	411	52,000	12.1	255	PCB5530FA
E 56/24/19	O_45724EC	107	337	337	36,000	6.98	179	PCB5724M1
E 60/22/16	O_46016EC	110	248	240	27,200	5.74	135	
E 60/31/22	O_46022EC	139	402	401	55,900	21.0	200	
E 65/32/27	O_46527EC	147	540	530	79,000	23.5	410	O0B652701
E 70/33/32	O_47133EC	149	683	676	102,000	23.3	495	
E 72/28/19	O_47228EC	137	368	363	50,300	15.0	250	O0B722801
E 80/38/20	O_48020EC	184	392	392	72,300	31.6	357	O0B8020B1
E 100/59/27	O_49928EC	274	738	692	202,000	90.6	980	

Refer to page 62 for additional hardware information.

TYPE/SIZE	ORDERING CODE	DIMENSIONS (mm)							
		A	B	C	D	E	F	L	M
E 40/17/11	O_44011EC	40.0 ± 0.51	17.0 ± 0.31	10.69 ± 0.31	10.0 min	27.6 min	10.7 ± 0.31	5.99 ± 0.25	8.86 nom
E 42/21/9	O_44016EC	42.15 ± 0.85	21.1 ± 0.2	9.0 ± 0.25	14.9 min	29.5 min	11.95 ± 0.25	5.94 ± 0.13	8.9 ± 0.25
E 43/21/15	O_44020EC	43.0 + 0/-1.7	21.0 ± 0.2	15.2 + 0/-0.6	14.8 + 0.6/-0	29.5 + 1.4/-0	12.2 + 0/-0.5	6.75 nom	8.65 nom
I 43/6/15	O_44020IC	43.0 + 0/-1.7	5.9 ± 0.2	15.2 + 0/-0.6					
E 43/21/20	O_44022EC	43.0 + 0/-1.7	21.0 ± 0.2	20.0 + 0/-0.8	14.8 + 0.6/-0	29.5 + 1.4/-0	12.2 + 0/-0.5	6.75 nom	8.65 nom
E 42/33/20	O_44033EC	42.0 + 1/-0.7	32.8 + 0/-0.4	20.0 + 1/-0.8	26.0 + 1/-0	29.5 + 1.4/-0	12.2 + 0/-0.5	5.98 ref	9.13 ref
E 41/17/12	O_44317EC	40.6 ± 0.65	16.6 ± 0.2	12.4 ± 0.3	10.4 min	28.6 min	12.45 ± 0.25	6.33 max	7.95 min
E 47/20/16	O_44721EC	46.9 ± 0.8	19.6 ± 0.2	15.6 ± 0.25	12.1 min	32.4 ± 0.65	15.6 ± 0.25	7.54 nom	7.87 min
E 56/28/21	O_45528EC	56.2 + 0/-2.1	27.5 ± 0.3	21.0 + 0/-0.8	18.5 + 0.8/-0	37.5 + 1.5/-0	17.2 + 0/-0.5	9.35 ref	10.15 ref
E 56/28/25	O_45530EC	56.2 + 0/-2.1	27.6 ± 0.38	24.61 ± 0.38	18.5 min	37.5 min	17.2 + 0/-0.5	9.35 ref	10.15 ref
E 56/24/19	O_45724EC	56.1 ± 1	23.6 ± 0.25	18.8 ± 0.25	14.6 ± 0.13	38.1 min	18.8 ± 0.25	9.5 nom	9.03 nom
E 60/22/16	O_46016EC	59.99 ± 0.78	22.3 ± 0.3	15.62 ± 0.38	13.8 min	44.0 min	15.62 ± 0.38	7.7 ± 0.25	14.49 ± 0.25
E 60/31/22	O_46022EC	60.3 ± 0.9	30.6 ± 0.3	22.3 ± 0.38	21.6 ± 0.3	42.3 ± 0.78	18.1 ± 0.25	9.0 ref	12.1 ref
E 65/32/27	O_46527EC	65.0 + 1.5/-1.2	32.8 + 0/-0.6	27.4 + 0/-0.8	22.0 + 0.8/-0	44.2 + 1.8/-0	20.0 + 0/-0.7	9.95 ref	12.72 ref
E 70/33/32	O_47133EC	70.5 ± 1	33.2 + 0/-0.5	32.0 + 0/-0.8	21.9 + 0.7/-0	48.0 + 1.5/-0	22.0 + 0/-0.7	11.25 nom	13.0 nom
E 72/28/19	O_47228EC	72.4 ± 0.76	27.9 ± 0.33	19.0 ± 0.33	17.8 min	52.6 min	19.0 ± 0.38	9.53 ± 0.38	16.9 min
E 80/38/20	O_48020EC	80.0 ± 1.6	38.1 ± 0.3	19.8 ± 0.4	28.2 ± 0.3	59.1 min	19.8 ± 0.4	11.25 nom	19.45 min
E 100/59/27	O_49928EC	100.3 ± 2.0	59.4 ± 0.47	27.5 ± 0.5	46.85 ± 0.38	72.0 min	27.5 ± 0.5	13.75 ± 0.38	22.65 ± 0.5

Planar E, I Cores

14 mm – 36 mm

Planar E cores are offered in all of the IEC standard sizes and a number of other sizes. The leg length and window height (B and D dimensions) are adjustable for specific applications without new tooling. This permits the designer to adjust the final core specification to exactly accommodate the planar conductor stack height with no wasted space. Clips and clip slots are available in many cases, which is useful for prototyping. I cores are also offered standard, reducing path length and increasing inductance. Planar cores provide the lowest profile design. E-I planar combinations allow practical face bonding in high volume assembly. The flat back can accommodate a heat sink.

Differential mode inductors, DC/DC, and AC/DC converters are typical applications for planar cores.

TYPE/SIZE	ORDERING CODE	NOMINAL A_L (mH/1000T)				
		L	R	P	F	T
14/2.5/5	O_41425EC	780	1,519	1,595	1,765	
E 14 C	C_41434EC	600	1,327	1,399	1,563	
I 14 C	C_41434IC	780	1,504	1,580	1,749	
E 18 C	C_41805EC	1,500	3,244	3,430	3,853	
I 18 C	C_41805IC	1,800	3,606	3,801	4,241	
E 18	F_41805EC	1,550	3,244	3,430	3,853	
I 18	F_41805IC	1,800	3,641	3,837	4,278	
E 22/4/7	O_42107EC	1,350	2,920	3,173	3,810	
I 22/4/7	O_42107IC	1,480	3,320	3,600	4,330	
E 22/6/16	O_42214EC		4,600			
I 22/2/6	O_42214IC		5,280			
E 22 C	C_42216EC	2,300	5,066	5,387	6,131	
I 22 C	C_42216IC	2,900	6,147	6,506	7,327	
E 22	F_42216EC	2,400	5,066	5,387	6,131	
I 22	F_42216IC	2,900	6,207	6,568	7,932	
E 22	F_42217EC		4,400			
E 32 C	C_43208EC	3,200	6,521	6,918	7,834	7,690
I 32 C	C_43208IC	3,700	7,321	7,745	8,711	8,520
E 32	F_43208EC	3,200	6,521	6,918	7,834	7,690
I 32	F_43208IC	3,700	7,321	7,745	8,711	8,520
E 36/6/18	O_43618EC		6,678	7,090		
I 36/6/18	O_43618IC		7,303	7,736		

HOW TO ORDER

C R 4 14 34 EC

Shape code ←
 Ferrite core material ←
 Used for all ferrite types ←
 Approximate length in mm ←
 Approximate width in mm ←
 Geometry code ←

SHAPE CODE

C – Planar core with clip recesses
 F or O – Planar core without clip recesses

GEOMETRY CODE

EC – Planar E core • IC – Planar I core

For clip slot dimensions see individual datasheets.
 Cores are sold per piece (for sets multiply by 2).
 See page 18 for information on gapped cores.
 For an E-core gapped to an A_L value when mated with the standard I-core, add “-EI” to the end of the part number.

E CORE

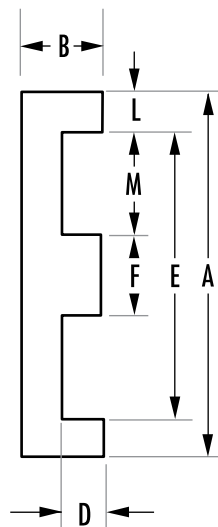

I CORE

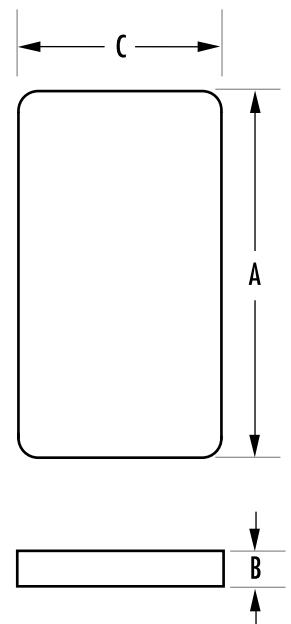



Refer to page 62 for additional hardware information.

TYPE/SIZE	ORDERING CODE	MAGNETIC DATA						HARDWARE	
		I _e (mm)	A _e (mm ²)	A _e min (mm ²)	V _e (mm ³)	WaAc (cm ⁴)	Weight (grams per set)	Clamps	
14/2.5/5	O_41425EC	16.7	14.7	14.7	244	0.01	1.2		
E 14 C	C_41434EC	20.7	14.7	14.7	304	0.02	1.5		
I 14 C	C_41434IC	16.4	14.2	11.4	230	0.008	1.2		
E 18 C	C_41805EC	24.2	40.1	39.9	972	0.07	4.8	OOC180520	
I 18 C	C_41805IC	20.3	39.5	35.9	830	0.03	4.1	OOC180520	
E 18	F_41805EC	24.2	40.1	39.9	972	0.07	4.8		
I 18	F_41805IC	20.3	40.1	39.9	813	0.03	3.9		
E 22/4/7	O_42107EC	25.7	37.1	36.0	960	0.06	4.2		
I 22/4/7	O_42107IC	22.7	35.7	33.5	809	0.03	3.9		
E 22/6/16	O_42214EC	32.5	78.3	77.9	2,540	0.29	6.1		
I 22/2/6	O_42214IC	26.1	79.0	78.5	2,060	0.14	3.9		
E 22 C	C_42216EC	32.3	76.0	73.1	2,451	0.27	12	OOC221620	
I 22 C	C_42216IC	26.1	80.4	72.5	2,100	0.14	10.4	OOC221620	
E 22	F_42216EC	32.5	78.5	76.0	2,550	0.27	12.5		
I 22	F_42216IC	25.8	80.6	80.6	2,080	0.13	10.2		
E 22	F_42217EC	35.1	82.1	79.0	2,880	0.36	14		
E 32 C	C_43208EC	41.4	130	130	5,380	0.71	26	OOC320802	
I 32 C	C_43208IC	35.1	130	130	4,560	0.36	22	OOC320802	
E 32	F_43208EC	41.4	130	130	5,380	0.71	26		
I 32	F_43208IC	35.1	130	130	4,560	0.36	22		
E 36/6/18	O_43618EC	42.4	135	135	5,750	0.55	28		
I 36/6/18	O_43618IC	37.4	135	135	5,060	0.27	25		

TYPE/SIZE	ORDERING CODE	DIMENSIONS (mm)							
		A	B	C	D	E	F	L	M
14/2.5/5	O_41425EC	14.0 ± 0.3	2.5 ± 0.1	5.0 ± 0.1	1.0 ± 0.1	11.0 ± 0.25	3.0 ± 0.1	1.5 ref	4.0 ref
E 14 C	C_41434EC	14.0 ± 0.3	3.5 ± 0.1	5.0 ± 0.15	1.91 min	10.5 min	3.0 ± 0.1	1.5 ref	4.0 ref
I 14 C	C_41434IC	14.0 ± 0.3	1.8 ± 0.05	5.0 ± 0.15	1.5 ± 0.1	2.5 + 0.2/-0			
E 18 C	C_41805EC	18.0 ± 0.35	4.0 ± 0.1	10.0 ± 0.2	2.0 ± 0.1	14 ± 0.3	4.0 ± 0.1	2.0 ref	5.0 ref
I 18 C	C_41805IC	18.0 ± 0.35	2.4 ± 0.5	10.0 ± 0.2	2.0 ± 0.1	2.5 + 0.2/-0			
E 18	F_41805EC	18.0 ± 0.35	4.0 ± 0.1	10.0 ± 0.2	2.0 ± 0.1	13.7 min	4.0 ± 0.1	2.0 ref	5.0 ref
I 18	F_41805IC	18.0 ± 0.41	2.39 ± 0.1	10.0 ± 0.2					
E 22/4/7	O_42107EC	21.8 ± 0.4	3.91 ± 0.8	7.8 ± 0.5	1.73 ± 0.2	16.8 ± 0.3	5.0 ± 0.2	2.5 ± 0.12	5.89 ± 0.25
I 22/4/7	O_42107IC	21.8 ± 0.4	2.3 ± 0.2	7.8 ± 0.3					
E 22/6/16	O_42214EC	21.8 ± 0.4	5.7 ± 0.1	15.8 ± 0.3	3.2 ± 0.1	16.8 +/- 0.4	5.0 ± 0.1	2.6 ref	5.9 ref
I 22/2/6	O_42214IC	21.8 ± 0.4	2.49 ± 0.13	15.8 ± 0.3					
E 22 C	C_42216EC	21.8 ± 0.4	5.7 ± 0.1	15.8 ± 0.3	3.05 min	16.1 min	5.0 ± 0.1	2.5 ref	5.9 ref
I 22 C	C_42216IC	21.8 ± 0.4	2.9 ± 0.05	15.8 ± 0.3	2.5 ± 0.1	2.9 + 0.2/-0			
E 22	F_42216EC	21.8 ± 0.4	5.72 ± 0.1	15.8 ± 0.3	3.05 min	16.1 min	5.0 ± 0.1	2.5 ref	5.9 ref
I 22	F_42216IC	21.8 ± 0.4	2.95 ± 0.1	15.8 ± 0.3					
E 22	F_42217EC	21.6 ± 0.25	6.55 ± 0.08	15.9 ± 0.25	3.9 ± 0.1	16.3 ± 0.3	5.0 ± 0.15	2.65 ref	5.65 ref
E 32 C	C_43208EC	31.75 ± 0.64	6.35 ± 0.13	20.32 ± 0.41	3.18 ± 0.2	24.9 min	6.35 ± 0.13	3.18 ref	9.27 ref
I 32 C	C_43208IC	31.75 ± 0.64	3.18 ± 0.13	20.32 ± 0.41					
E 32	F_43208EC	31.75 ± 0.64	6.35 ± 0.13	20.32 ± 0.41	3.18 ± 0.2	24.9 min	6.35 ± 0.13	3.18 ref	9.27 ref
I 32	F_43208IC	31.75 ± 0.64	3.18 ± 0.13	20.32 ± 0.41					
E 36/6/18	O_43618EC	35.56 ± 0.5	6.35 ± 0.13	17.8 ± 0.4	2.41 min	27.2 min	7.62 ± 0.18	3.81 ± 0.13	10.16 ± 0.25
I 36/6/18	O_43618IC	35.56 ± 0.5	3.68 ± 0.3	17.8 ± 0.4					

Planar E, I Cores

38 mm – 102 mm



TYPE/SIZE	ORDERING CODE	NOMINAL A_L (mH/1000T)				
		L	R	P	F	J
E 38	F_43808EC	3,880	7,618	8,354	9,490	
I 38	F_43808IC	4,600	9,028	9,566	10,801	
E 38	F_43809EC		7,300			
E 40/8/10	O_44008EC		4,233	4,504	5,134	7,130
I 40/4/10	O_44008IC		4,744	5,035	5,706	8,026
E 43/8/28	O_44308EC		8,598	9,150	10,432	
I 43/4/28	O_44308IC		9,541	10,130	11,849	
E 43	F_44310EC		8,266	8,803	10,057	
I 43	F_44310IC		9,541	10,130	11,489	
E 58 C	C_45810EC		8,498	9,073	10,427	
I 58 C	C_45810IC		9,821	10,457	11,941	
E 58	F_45810EC		8,498	9,073	10,427	
I 58	F_45810IC		9,821	10,457	11,941	
E 64 C	C_46410EC		14,618	15,599	17,901	
E 64	F_46410EC		14,618	15,599	17,901	
I 64	F_46410IC		16,192	17,245	19,699	
E 102	O_49938EC		9,292	9,997	11,697	

HOW TO ORDER

C R 4 64 10 EC

Shape code ←
 Ferrite core material ←
 Used for all ferrite types ←
 Approximate length in mm ←
 Approximate width in mm ←
 Geometry code ←

SHAPE CODE

C – Planar core with clip recesses
 F or O – Planar core without clip recesses

GEOMETRY CODE

EC – Planar E core
 IC – Planar I core

For clip slot dimensions see individual datasheets.
 Cores are sold per piece (for sets multiply by 2).
 See page 18 for information on gapped cores.
 For an E-core gapped to an A_L value when mated with the standard I-core, add “-EI” to the end of the part number.

E CORE

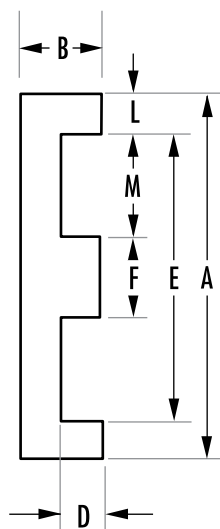

I CORE

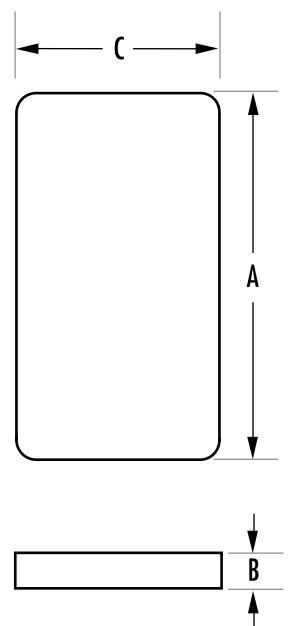



TYPE/SIZE	ORDERING CODE	MAGNETIC DATA						HARDWARE
		I_e (mm)	A_e (mm ²)	A_e min (mm ²)	V_e (mm ³)	$WaAc$ (cm ⁴)	Weight (grams per set)	Clamps
E 38	F_43808EC	52.4	194	194	10,200	1.88	51	
I 38	F_43808IC	43.7	194	194	8,460	0.94	42	
E 38	F_43809EC	57.8	192	191	11,100	2.48	55	
E 40/8/10	O_44008EC	51.9	101	95.1	5,220	0.77	26	
I 40/4/10	O_44008IC	43.8	99.5	95.1	4,360	0.38	21	
E 43/8/28	O_44308EC	57.5	227	227	13,100	2.52	64	
I 43/4/28	O_44308IC	48.6	227	227	11,000	1.27	54	
E 43	F_44310EC	61.1	229	229	13,900	3.18	71	
I 43	F_44310IC	50.4	229	229	11,500	1.59	58	
E 58 C	C_45810EC	80.6	308	308	24,600	8.16	119	00C581001
I 58 C	C_45810IC	67.7	310	310	20,800	4.09	101	00C581002
E 58	F_45810EC	80.6	308	308	24,600	8.16	119	
I 58	F_45810IC	68.3	310	310	20,829	4.09	101	
E 64 C	C_46410EC	80.2	516	516	41,400	11.10	195	00C641001
E 64	F_46410EC	80.2	516	516	41,400	11.10	200	
I 64	F_46410IC	69.6	511	511	35,539	5.52	172	
E 102	O_49938EC	148	540	525	79,800	50.5	400	

Refer to page 62 for additional hardware information.

TYPE/SIZE	ORDERING CODE	DIMENSIONS (mm)							
		A	B	C	D	E	F	L	M
E 38	F_43808EC	38.1 ± 0.76	8.26 ± 0.13	25.4 ± 0.51	4.45 ± 0.13	30.23 min	7.62 ± 0.15	3.81	11.43
I 38	F_43808IC	38.1 ± 0.76	3.81 ± 0.13	25.4 ± 0.51					
E 38	F_43809EC	38.1 ± 0.76	9.53 ± 0.13	25.4 ± 0.51	5.72 ± 0.13	30.23 min	7.62 ± 0.15	3.81	11.43
E 40/8/10	O_44008EC	40.65 ± 0.5	8.51 ± 0.25	10.7 ± 0.25	4.06 ± 0.25	30.45 ± 0.3	10.15 ± 0.15	5.1 ref	10.15 ref
I 40/4/10	O_44008IC	40.64 ± 0.5	4.45 ± 0.25	10.7 ± 0.25					
E 43/8/28	O_44308EC	43.2 ± 0.5	8.51 ± 0.25	27.9 ± 0.38	4.19 min	34.4 min	8.13 ± 0.13	4.2 nom	13.46 nom
I 43/4/28	O_44308IC	43.2 ± 0.9	4.1 ± 0.13	27.9 ± 0.6					
E 43	F_44310EC	43.2 ± 0.9	9.50 ± 0.13	27.9 ± 0.6	5.4 ± 0.13	34.7 min	8.1 ± 0.2	4.7 max	13.2 min
I 43	F_44310IC	43.2 ± 0.9	4.1 ± 0.13	27.9 ± 0.6					
E 58 C	C_45810EC	58.42 ± 1.2	10.54 ± 0.2	38.1 ± 0.8	6.35 min	50.0 min	8.1 ± 0.2	3.7 ref	21.4 ref
I 58 C	C_45810IC	58.42 ± 1.2	4.06 ± 0.13	38.1 ± 0.8					
E 58	F_45810EC	58.42 ± 1.2	10.54 ± 0.2	38.1 ± 0.8	6.35 min	50.0 min	8.1 ± 0.2	3.7 ref	21.4 ref
I 58	F_45810IC	58.42 ± 1.2	4.06 ± 0.13	38.1 ± 0.8					
E 64 C	C_46410EC	64.0 ± 0.76	10.2 ± 0.1	50.8 ± 0.81	5.03 min	53.16 min	10.16 ± 0.18	5.08 ± 0.12	21.8 ± 0.25
I 64 C	C_46410IC	64.0 ± 1.27	5.08 ± 0.13	50.8 ± 1.02					
E 64	F_46410EC	64.0 ± 0.76	10.2 ± 0.1	50.8 ± 0.81	5.03 min	53.16 min	10.16 ± 0.18	5.08 ± 0.12	21.8 ± 0.25
I 64	F_46410IC	64.0 ± 1.27	5.08 ± 0.13	50.8 ± 1.02					
E 102	O_49938EC	102.0 ± 1.0	20.3 ± 0.25	37.5 ± 0.4	13.3 ± 0.25	86.0 ± 1.0	14.0 ± 0.25	8.0 ref	36.0 ref

ER Cores

ER cores are a cross between planar E cores and pot cores. The round center post of the ER core offers minimal winding resistance. In addition, they offer better space utilization and shielding than with rectangular center leg planar cores. When compared with non-planar cores, ERs offer minimal height and better thermal performance. E/I combinations facilitate economical assembly.

Typical applications of ER cores include differential mode inductors and power transformers.

TYPE/SIZE	ORDERING CODE	NOMINAL A_L (mH/1000T)			
		L	R	P	F
ER 9/5	O_40906EC	525	973	1,053	1,270
ER 11/6	O_41126EC	725	1,400	1,690	1,780
ER 12.5/8.5	O_41308EC	950	1,700	1,800	1,950
I 12.5/8.5	O_41308IC	1,000	1,800	1,900	2,000
ER 14.5/6	O_41426EC	850	1,600	1,700	1,850
ER 18/3/10	O_41826EC	1,300	2,623	2,770	3,104
ER 20/7/14	C_42014EC	1,600	3,788	4,026	4,575
I 20/7/14	C_42014IC	2,150	4,500	4,900	5,500
ER 20/7/14	F_42014EC	1,600	3,788	4,026	4,575
I 20/7/14	F_42014IC	2,150	4,479	4,740	5,338
ER 23/3/12	O_42313EC	1,850	3,800	4,030	4,540
ER 25/5.5/18	O_42517EC	2,650	5,700	6,050	6,900
I 25/2/18	O_42517IC	3,300	7,021	7,447	8,427
ER 25/8/18	O_42521EC	2,300	5,440	5,801	6,649
ER 30/8/20	O_43021EC	2,400	5,465	5,841	6,729
I 30/2.5/20	O_43021IC	3,200	6,550	7,784	8,850
ER 32/6/25	O_43225EC		6,950	7,350	8,200

HOW TO ORDER

O R 4 0 9 0 6 E C

- Shape code ←
- Ferrite core material ←
- Used for all ferrite types ←
- Approximate length in mm ←
- Approximate depth in mm ←
- Geometry code ←

SHAPE CODE

- C – ER core with clip recesses
- F or O – ER core without clip recesses

GEOMETRY CODE

- EC – ER core
- IC – I core

For clip slot dimensions see individual datasheets.
 ER cores are sold per piece (for sets multiply by 2).
 See page 18 for information on gapped cores.
 For an E-core gapped to an A_L value when mated with the standard I-core, add “-EI” to the end of the part number.

ER CORE

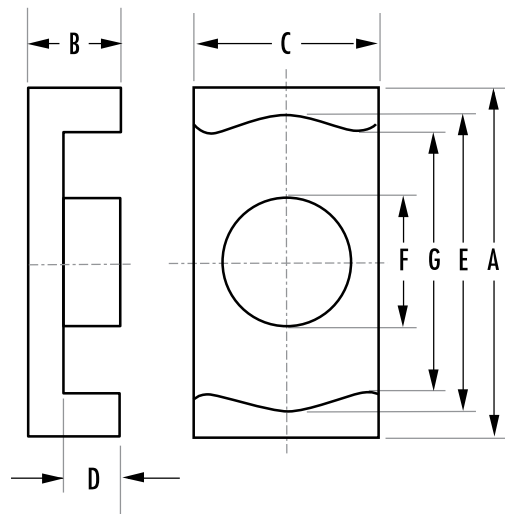

I CORE

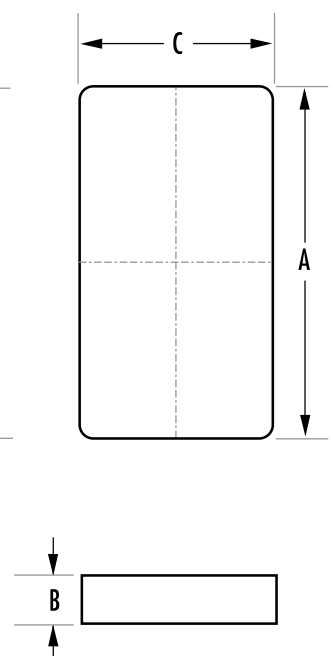



TYPE/SIZE	ORDERING CODE	MAGNETIC DATA						HARDWARE
		I _e (mm)	A _e (mm ²)	A _e min (mm ²)	V _e (mm ³)	WaAc (cm ⁴)	Weight (grams per set)	Bobbins
ER 9/5	O_40906EC	14.2	8.47	7.6	120	0.003	1	SMB09068A
ER 11/6	O_41126EC	14.7	11.9	10.3	174	0.004	1	
ER 12.5/8.5	O_41308EC	17.5	19.9	19.2	348	0.011	2	
I 12.5/8.5	O_41308IC	15.9	19.8	19.2	315	0.006	1	
ER 14.5/6	O_41426EC	19.0	17.6	17.3	333	0.011	2	
ER 18/3/10	O_41826EC	22.1	30.2	30.1	667	0.025	3	
ER 20/7/14	C_42014EC	33.2	59.0	55.0	1,960	0.142	10.2	
I 20/7/14	C_42014IC	25.1	59.8	55.0	1,500	0.072	8.0	
ER 20/7/14	F_42014EC	33.2	59.0	55.0	1,960	0.142	10.1	
I 20/7/14	F_42014IC	25.5	57.3	52.5	1,460	0.069	8.0	
ER 23/3/12	O_42313EC	26.6	50.2	50.0	1,340	0.055	6.4	
ER 25/5.5/18	O_42517EC	33.8	91.8	86.4	3,100	0.151	16.4	
I 25/2/18	O_42517IC	26.4	89.7	82.8	2,370	0.076	13.1	
ER 25/8/18	O_42521EC	41.4	100	95.0	4,145	0.324	22.0	
ER 30/8/20	O_43021EC	46.0	108	95.0	4,970	0.488	26.4	
I 30/2.5/20	O_43021IC	36.2	108	95.0	3,910	0.244	20.8	
ER 32/6/25	O_43225EC	38.2	141	121	5,400	0.328	27.5	

Refer to page 62 for additional hardware information.

TYPE/SIZE	ORDERING CODE	DIMENSIONS (mm)						
		A	B	C	D	E	F	G
ER 9/5	O_40906EC	9.5 +0/-0.3	2.45 ± 0.05	5.0 +0/-0.2	1.6 +0.15/-0	7.5 +0.4/-0	3.5 +0/-0.2	7.1 +0.35/-0
ER 11/6	O_41126EC	11.0 +0/-0.35	2.45 ± 0.05	6.0 +0/-0.2	1.5 +0.15/-0	8.7 +0.3/-0	4.25 +0/-0.25	8.0 +0/-0.25
ER 12.5/8.5	O_41308EC	12.8 ± 0.3	2.85 ± 0.8	8.7 ± 0.25	1.75 ± 0.13	11.2 ± 0.3	5.0 ± 0.15	9.05 ± 0.3
I 12.5/8.5	O_41308IC	12.8 ± 0.3	1.1 ± 0.1	8.7 ± 0.25				
ER 14.5/6	O_41426EC	14.7 +0/-0.4	2.95 ± 0.5	6.8 +0/-0.2	1.55 +0.2/-0	11.6 +0.4/-0	4.8 +0/-0.2	
ER 18/3/10	O_41826EC	18.0 ± 0.35	3.15 ± 0.1	9.7 ± 0.2	1.6 ± 0.1	15.6 ± 0.3	6.2 ± 0.15	13.5 min
ER 20/7/14	C_42014EC	20.0 ± 0.35	6.8 ± 0.1	14.0 ± 0.3	4.6 ± 0.15	18 ± 0.35	8.8 ± 0.15	12.86 ± 0.35
I 20/7/14	C_42014IC	20.0 ± 0.35	2.3 ± 0.05	14.0 ± 0.3	1.9 ± 0.1	3.0 ± 0.1		
ER 20/7/14	F_42014EC	20.0 ± 0.35	6.8 ± 0.1	14.0 ± 0.3	4.6 ± 0.15	18.0 ± 0.35	8.8 ± 0.15	12.86 ± 0.35
I 20/7/14	F_42014IC	20.0 ± 0.35	1.9 ± 0.05	14.0 ± 0.3				
ER 23/3/12	O_42313EC	23.2 ± 0.45	3.6 ± 0.1	12.5 ± 0.25	1.6 ± 0.1	20.2 ± 0.4	8.0 ± 0.2	17.5 min
ER 25/5.5/18	O_42517EC	25.0 ± 0.4	5.6 ± 0.1	18.0 ± 0.3	2.75 ± 0.15	22.0 ± 0.4	11.0 ± 0.2	15.2 ± 0.7
I 25/2/18	O_42517IC	25.0 ± 0.4	2.3 ± 0.05	18.0 ± 0.3				
ER 25/8/18	O_42521EC	25.0 ± 0.4	8.0 ± 0.1	18.0 ± 0.3	5.15 ± 0.15	22.0 ± 0.4	11.0 ± 0.2	15.2 ± 0.7
ER 30/8/20	O_43021EC	30.0 ± 0.4	8.0 ± 0.15	20.0 ± 0.3	5.3 ± 0.2	26.0 ± 0.4	11.0 ± 0.2	19.45 ± 0.4
I 30/2.5/20	O_43021IC	30.0 ± 0.4	2.7 ± 0.1	20.0 ± 0.3				
ER 32/6/25	O_43225EC	32.1 +0.55/-0.45	6.0 ± 0.13	25.4 ± 0.4	2.9 +0/-0.25	27.2 ± 0.4	12.4 ± 0.15	27.2 ± 0.4

U, I Cores

U cores are ideal for many power transformer applications. The long legs support low leakage inductance designs and facilitate superior voltage isolation. U/I combinations provide for economical assembly.

TYPE/SIZE	ORDERING CODE	NOMINAL A_L (mH/1000T)					
		L	R	P	F	J	W
U 11/4/6	0_41106UC		860	914	1,010	1,662	
I 11/2/6	0_41106IC		960	1,020	1,150	1,687	
U 22/21/6	0_42220UC		893	973	1,360	2,107	3,429
U 25/13/13	0_42512UC		1,907	2,067	2,480	4,400	
U 25/16/6	0_42515UC		1,107	1,333	1,600	2,507	
I 25/6/6	0_42516IC	660	1,480	1,650	1,770	2,907	
U 25/16/12	0_42530UC		2,093	2,280	2,740	4,860	
U 93/76/16	0_49316UC		3,450	3,730	4,110	8,100	
I 93/28/16	0_49316IC		4,600	4,960	5,840	10,500	
U 93/76/30	0_49330UC			7,219			
U 93/76/32	0_49332UC			7,700			
U 126/91/20	0_49920UC		3,000	3,572	4,265	6,967	
U 102/57/25	0_49925UC		4,533	5,500	6,500		
I 102/25/25	0_49925IC		5,707	6,200	7,440		

HOW TO ORDER

O F 4 22 20 UC

Shape code ←
 Ferrite core material ←
 Used for all ferrite types ←
 Approximate length in mm ←
 Approximate width in mm ←
 Geometry code ←

GEOMETRY CODE

UC – U core
 IC – I core

U and I cores are sold per piece (for sets multiply by 2).

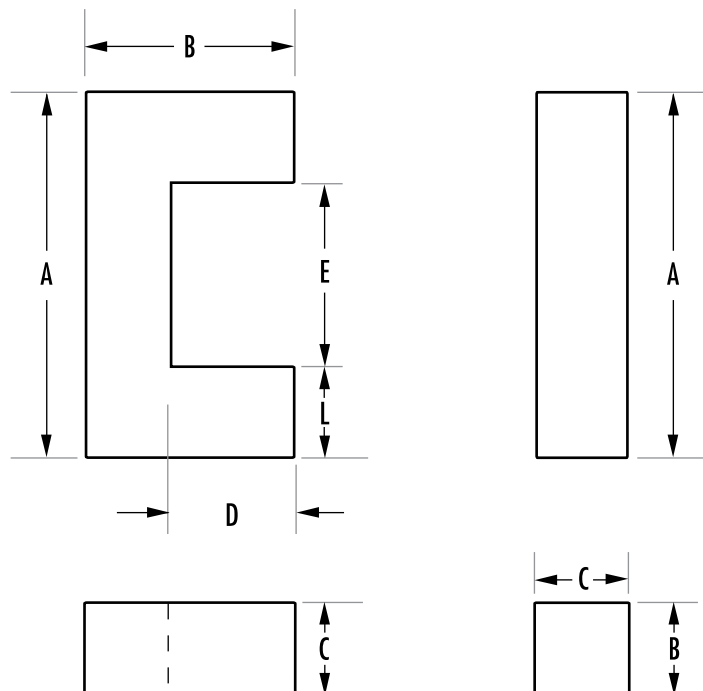

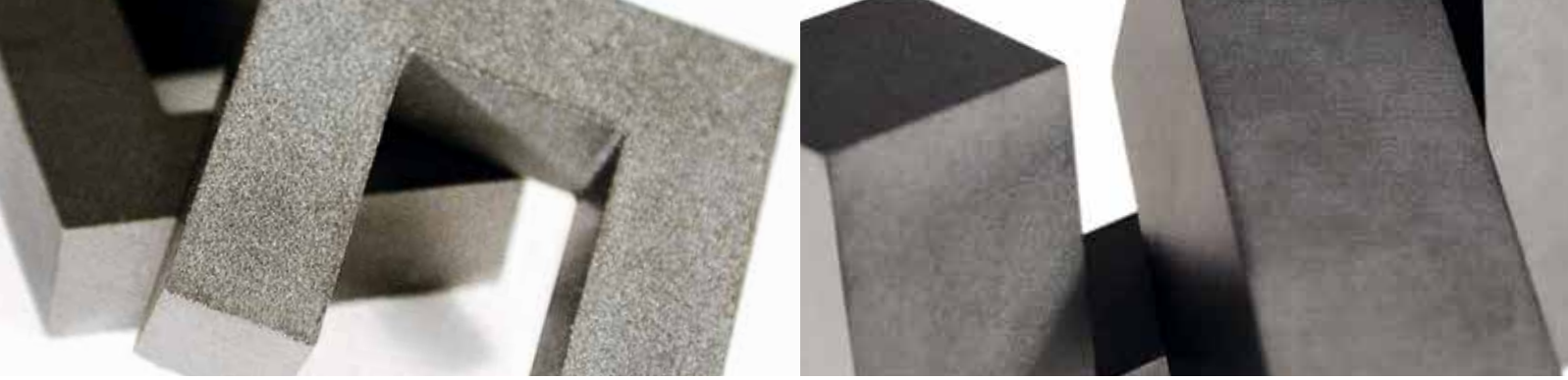

TYPE/SIZE	ORDERING CODE	MAGNETIC DATA						HARDWARE
		I _e (mm)	A _e (mm ²)	A _e min (mm ²)	V _e (mm ³)	WaAc (cm ⁴)	Weight (grams per set)	Bobbins
U 11/4/6	0_41106UC	29.2	12	11.5	350	0.02	1.8	
I 11/2/6	0_41106IC	24.6	11.5	11.5	283	0.01	1.5	
U 22/21/6	0_42220UC	95.8	39.7	39.7	4,130	0.63	19	
U 25/13/13	0_42512UC	68.9	80.0	80.0	4,170	0.78	29	
U 25/16/6	0_42515UC	83.4	40.4	40.4	3,370	0.57	17	
I 25/6/6	0_42516IC	64.3	40.3	40.3	2,590	0.32	13	
U 25/16/12	0_42530UC	83.4	80.8	80.8	6,740	1.13	34	
U 93/76/16	0_49316UC	353	452	452	160,000	91.4	800	
I 93/28/16	0_49316IC	257	450	450	115,000	45.8	600	
U 93/76/30	0_49330UC	354	840	840	297,000	173	1,490	
U 93/76/32	0_49332UC	353	905	896	319,000	185	1,600	
U 126/91/20	0_49920UC	480	560	560	268,800	286	1,360	
U 102/57/25	0_49925UC	308	645	645	199,000	121	988	
I 102/25/25	0_49925IC	245	645	645	158,000	60.7	784	

Refer to page 62 for additional hardware information.

TYPE/SIZE	ORDERING CODE	DIMENSIONS (mm)					
		A	B	C	D	E	L
U 11/4/6	0_41106UC	10.85 ± 0.2	4.19 ± 0.13	6.3 ± 0.13	2.24 ± 0.13	7.19 ± 0.2	1.83 ± 0.13
I 11/2/6	0_41106IC	10.8 ± 0.2	1.83 ± 0.12	6.3 ± 0.13			
U 22/21/6	0_42220UC	22.1 ± 0.38	20.6 ± 0.38	6.27 ± 0.18	13.98 min	9.5 ± 0.38	6.27 ± 0.18
U 25/13/13	0_42512UC	25.4 ± 0.5	12.9 ± 0.4	12.7 ± 0.4	6.35 min	12.8 ref	6.3 ± 0.13
U 25/16/6	0_42515UC	25.4 ± 0.51	15.9 ref	6.35 ± 0.12	9.27 min	12.7 ref	6.45 ± 0.15
I 25/6/6	0_42516IC	25.4 + 0.64/-0.51	6.35 ± 0.13	6.35 ± 0.13			
U 25/16/12	0_42530UC	25.4 ± 0.51	15.9 ref	12.7 ± 0.25	9.27 min	12.7 ref	6.45 ± 0.15
U 93/76/16	0_49316UC	93.0 ± 1.8	76.0 ± 0.5	16.0 ± 0.6	48.0 ± 0.9	36.2 ± 1.2	28.4 ref
I 93/28/16	0_49316IC	93.0 ± 1.8	27.5 ± 0.5	16.0 ± 0.6			
U 93/76/30	0_49330UC	93.0 ± 1.8	76.0 ± 0.5	30.0 ± 0.6	48.0 ± 0.9	36.2 ± 1.2	28.4 ref
U 93/76/32	0_49332UC	93.0 ± 1.8	76.0 ± 0.5	32.0 ± 0.6	48.0 ± 0.9	36.2 ± 1.2	28.4 ref
U 126/91/20	0_49920UC	126.0 ± 4.0	91.0 ± 1.0	20.0 ± 0.6	63.0 ± 2.0	70.0 ± 2.0	28.0 ref
U 102/57/25	0_49925UC	101.6 ± 1.5	57.1 ± 0.4	25.4 ± 0.6	31.7 ± 0.75	50.8 ± 1	25.4 ± 0.8
I 102/25/25	0_49925IC	101.6 ± 1.5	25.4 ± 0.4	25.4 ± 0.6			

UR Cores

UR cores are an excellent choice for high current designs and conditions where vibration occurs. The open window area accommodates large conductors. Holes through the center or grooves on the outer legs of the core provide a method to secure the core to the PCB with mounting hardware.

Typical applications include welding output transformers, audio amplifiers, traction, and other high-voltage power transformers.

TYPE/SIZE	ORDERING CODE	NOMINAL A_L (mH/1000T)		
		R	P	F
UR 41/21/11	0_44119UC	1,627	1,773	2,130
UR 41/21	0_44121UC	1,880	2,047	2,465
UR 41/25	0_44125UC	1,600	1,747	2,105
UR 41/30	0_44130UC	1,400	1,520	1,830
UR 57	0_45716UC	2,600	3,061	3,622
UR 59	0_45917UC	3,027	3,274	3,881
UR 64*	0_46420UC	3,787	4,098	4,864

HOW TO ORDER

OP 44125 UC

- Shape code ←
- Ferrite core material ←
- Used for all ferrite types ←
- Approximate length in mm ←
- Approximate depth in mm ←
- Geometry code ←

UR cores are sold per piece (for sets multiply by 2).
 *For UR 64 size, refer to datasheets for differences in geometry.

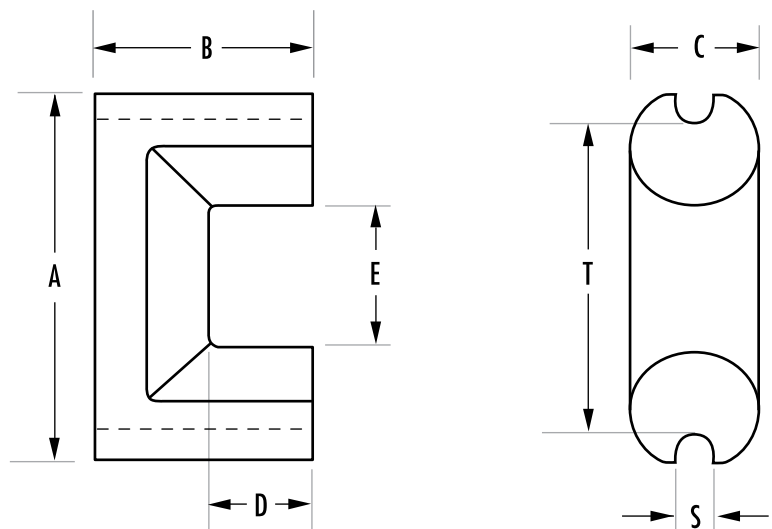



TYPE/SIZE	ORDERING CODE	MAGNETIC DATA						HARDWARE
		I _e (mm)	A _e (mm ²)	A _e min (mm ²)	V _e (mm ³)	WaAc (cm ⁴)	Weight (grams per set)	Bobbins
UR 41/21/11	0_44119UC	121.2	91.1	80.5	11,000	2.75	54	00B411901
UR 41/21	0_44121UC	113	104	84.0	11,800	2.81	55	
UR 41/25	0_44125UC	134.4	113.1	105.4	15,196	4.0	64	
UR 41/30	0_44130UC	154.8	112.1	105.4	17,346	5.25	75	
UR 57	0_45716UC	163	171	171	27,900	8.84	140	
UR 59	0_45917UC	189	210	210	39,700	13.8	198	
UR 64	0_46420UC	210	290	290	61,000	21.9	320	

Refer to page 62 for additional hardware information.

TYPE/SIZE	ORDERING CODE	DIMENSIONS (mm)						
		A	B	C	D	E	S	T
UR 41/21/11	0_44119UC	41.78 ± 0.81	20.9 ± 0.12	11.94 ± 0.25	13.4 min	18.8 ± 0.56	3.18 nom	34.66 ref
UR 41/21	0_44121UC	41.78 ± 0.81	20.62 ± 0.13	11.94 ± 0.25	11.1 ± 0.2	18.8 ± 0.56	3.18 ± 0.13	34.66 nom
UR 41/25	0_44125UC	41.78 ± 0.81	25.4 ± 0.13	11.94 ± 0.25	15.9 ± 0.2	18.8 ± 0.56	3.18 ± 0.13	34.66 nom
UR 41/30	0_44130UC	41.78 ± 0.81	30.5 ± 0.3	11.94 ± 0.25	20.8 min	18.8 ± 0.56	3.18 ± 0.13	34.66 ref
UR 57	0_45716UC	57.65 ± 1.7	28.6 + 0/-0.4	15.9 ± 0.4	15.5 + 1/-0	27.8 ± 0.9	4.8 ± 0.2	49.8 ± 0.8
UR 59	0_45917UC	59.34 ± 1.75	35.8 ± 0.4	17.0 ± 0.4	21.5 ± 0.8	26.5 ± 0.1	4.5 ± 0.2	50.5 ± 0.1
UR 64	0_46420UC	64.0 ± 1.95	40.5 ± 0.2	24.0 ± 0.3	26.5 ± 0.4	24.1 ± 0.9	4.0 min	44.0 ± 0.6

EC Cores

The round center leg and open window of EC cores allow for minimum winding resistance and efficient assembly. Long legs promote low and controlled leakage inductance and are useful for high voltage applications.

EC cores have standard channels for clamping assemblies. Plain bobbins, printed circuit bobbins and clamps are available for most sizes.

Magnetics EC cores are typically used in differential mode inductor and power transformer applications.

TYPE/SIZE	ORDERING CODE	NOMINAL A_L (mH/1000T)		
		R	P	F
EC 35	0_43517EC	2,213	2,400	3,000
EC 41	0_44119EC	2,947	3,200	3,700
EC 52	0_45224EC	3,867	4,200	5,040
EC 70	0_47035EC	4,413	4,800	5,760

HOW TO ORDER

OR 47035 EC

- Shape code ←
- Ferrite core material ←
- Used for all ferrite types ←
- Approximate length in mm ←
- Approximate width in mm ←
- Geometry code ←

EC cores are sold per piece (for sets multiply by 2).
See page 18 for information on gapped cores.

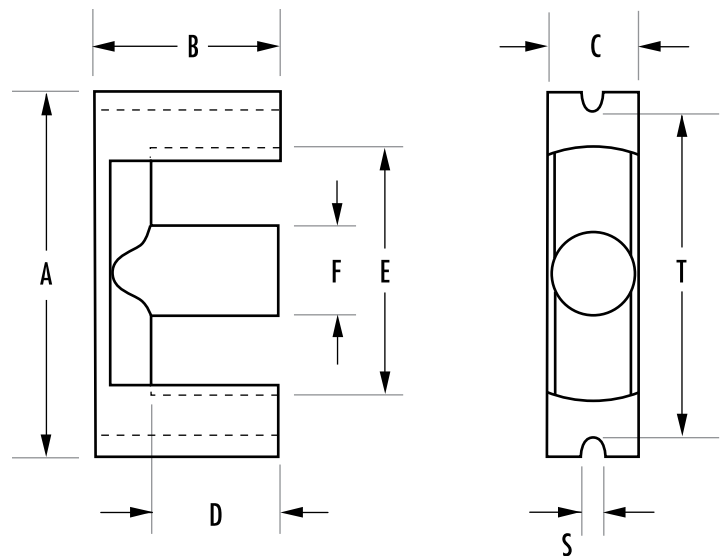

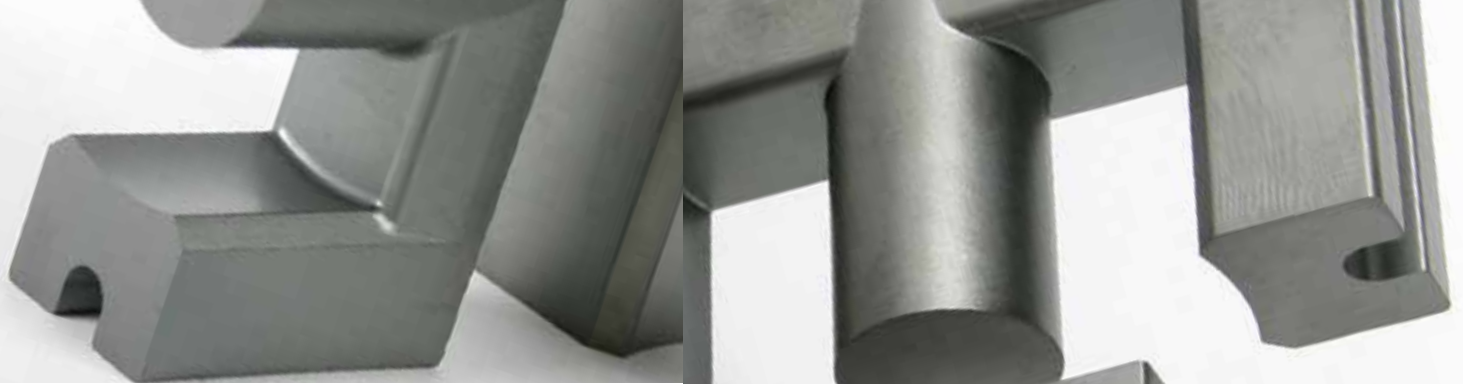

TYPE/SIZE	ORDERING CODE	MAGNETIC DATA						HARDWARE
		I _e (mm)	A _e (mm ²)	A _e min (mm ²)	V _e (mm ³)	WaAc (cm ⁴)	Weight (grams per set)	Bobbins
EC 35	0_43517EC	77.4	84.3	71	6,530	0.83	36	PCB351701
EC 41	0_44119EC	89.3	121	106	10,800	1.67	60	00B411901
EC 52	0_45224EC	105	180	141	18,800	3.87	111	00B5224B1
EC 70	0_47035EC	144	279	211	40,100	13.4	253	PCB703501

Refer to page 62 for additional hardware information.

TYPE/SIZE	ORDERING CODE	DIMENSIONS (mm)							
		A	B	C	D	E	F	S	T
EC 35	0_43517EC	34.5 ± 0.8	17.3 ± 0.15	9.5 ± 0.3	12.3 ± 0.4	22.75 ± 0.55	9.5 ± 0.3	2.75 ± 0.25	28.5 ± 0.8
EC 41	0_44119EC	40.6 ± 1.0	19.5 ± 0.15	11.6 ± 0.3	13.9 ± 0.4	27.7 ± 0.7	11.6 ± 0.3	3.25 ± 0.25	33.6 ± 1
EC 52	0_45224EC	52.2 ± 1.3	24.2 ± 0.15	13.4 ± 0.35	15.9 ± 0.4	33.0 ± 0.9	13.4 ± 0.35	3.75 ± 0.25	44.0 ± 1.3
EC 70	0_47035EC	70.0 ± 1.7	34.5 ± 0.15	16.4 ± 0.4	22.75 ± 0.45	44.5 ± 1.2	16.4 ± 0.4	4.75 ± 0.25	59.6 ± 1.7

EER Cores

EER cores are an economical choice for transformers and inductors. The round center leg offers the advantage of a shorter winding path length than winding around a square center leg of equal area.

Differential mode inductors and power transformers are typical applications for Magnetics EER cores.

TYPE/SIZE	ORDERING CODE	NOMINAL A_L (mH/1000T)			
		L	R	P	F
EER 28/14/11	0_42814EC	1,340	2,700	3,352	3,896
EER 28/16/11	0_42817EC	1,150	2,500	2,913	3,400
EER 35L	0_43521EC		2,693	2,960	3,550
EER 40/22/13	0_44013EC		3,300	3,520	4,000
EER 42	0_44216EC		3,840	4,173	5,000
EER 48/18/17	0_44818EC		6,400	6,850	7,950
EER 48/21/21	0_44821EC		5,700	7,059	8,274
EER 53/18/18	0_45418EC		6,100	6,500	7,440

HOW TO ORDER

OR 44216 EC

Shape code ←
 Ferrite core material ←
 Used for all ferrite types ←
 Approximate length in mm ←
 Approximate height or width in mm ←
 Geometry code ←

EER cores are sold per piece (for sets multiply by 2).
 See page 18 for information on gapped cores.

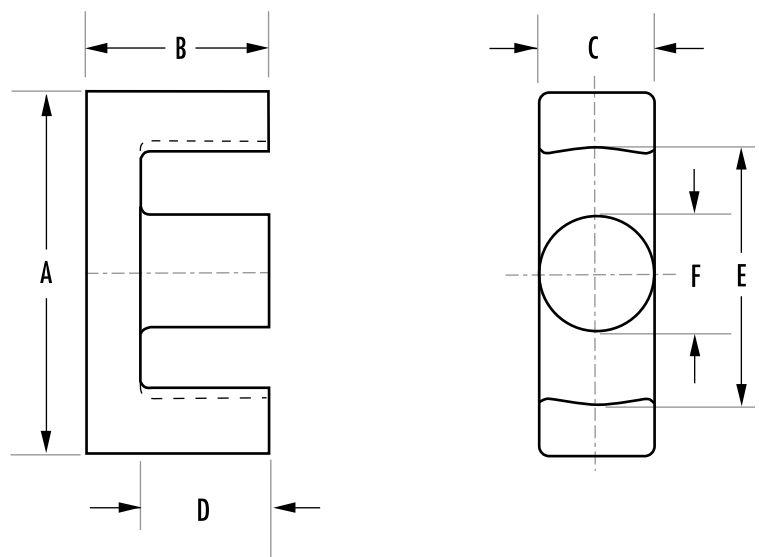

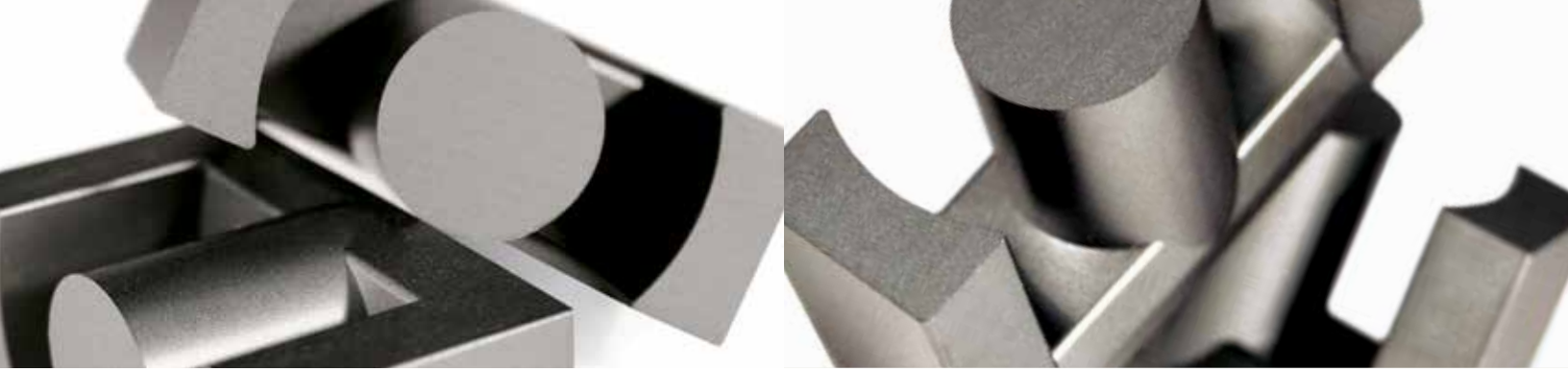

TYPE/SIZE	ORDERING CODE	MAGNETIC DATA						HARDWARE
		I _e (mm)	A _e (mm ²)	A _e min (mm ²)	V _e (mm ³)	WaAc (cm ⁴)	Weight (grams per set)	Bobbins
EER 28/14/11	0_42814EC	64.0	81.4	77.0	5,260	0.532	28	
EER 28/16/11	0_42817EC	75.5	81.4	77.0	6,142	0.693	32	
EER 35L	0_43521EC	90.8	107	100	9,710	1.58	49	PCB3521LA
EER 40/22/13	0_44013EC	98.0	149	139	14,600	2.16	74	
EER 42	0_44216EC	98.7	175	166	17,300	2.98	106	PCB4216FA
EER 48/18/17	0_44818EC	86.0	232	223	19,900	2.93	102	
EER 48/21/21	0_44821EC	100	255	248	25,500	4.43	128	
EER 53/18/18	0_45418EC	91.8	250	240	23,000	3.61	122	

Refer to page 62 for additional hardware information.

TYPE/SIZE	ORDERING CODE	DIMENSIONS (mm)					
		A	B	C	D	E	F
EER 28/14/11	0_42814EC	28.55 ± 0.55	14 ± 0.2	11.4 ± 0.35	9.75 ± 0.4	21.75 ± 0.5	9.9 ± 0.25
EER 28/16/11	0_42817EC	28.55 ± 0.55	16.7 ± 0.25	11.4 ± 0.35	12.65 ± 0.4	21.75 ± 0.5	9.9 ± 0.25
EER 35L	0_43521EC	35.0 ± 0.65	20.7 ± 0.2	11.4 ± 0.35	14.75 ± 0.35	26.15 ± 0.55	11.3 ± 0.25
EER 40/22/13	0_44013EC	40.0 ± 0.7	22.4 ± 0.2	13.4 ± 0.35	15.45 ± 0.35	29.6 ± 0.6	13.3 ± 0.25
EER 42	0_44216EC	42.15 ± 0.85	21.0 ± 0.2	14.7 ± 0.3	15.6 min	31.0 ± 0.6	14.7 ± 0.3
EER 48/18/17	0_44818EC	48.0 ± 1.0	18.0 ± 0.2	17.6 ± 0.4	11.45 ± 0.25	36.8 ± 0.8	17.6 ± 0.4
EER 48/21/21	0_44821EC	48.0 ± 1.0	21.2 + 0/-0.4	21 + 0.3/-0.5	14.7 + 0.7/-0	38 + 0.5/-0.8	18.0 ± 0.3
EER 53/18/18	0_45418EC	53.5 ± 1.0	18.3 ± 0.2	17.95 ± 0.35	11.1 ± 0.3	40.65 ± 0.85	17.9 ± 0.4

EFD Cores

The industry standard flat design of EFD cores offers excellent space utilization for transformers or inductors. The optimized cross-sectional area is ideal for very flat compact transformer applications.

EFD cores are designed for compact transformers and inductor applications.

TYPE/SIZE	ORDERING CODE	NOMINAL A_L (mH/1000T)					
		L	R	P	F	T	J
EFD 10	0_41009EC	280	585	622	698		923
EFD 12	0_41212EC	380	760	800	844		2,600
EFD 15	0_41515EC	400	893	973	1,170	1,140	1,933
EFD 20	0_42019EC	650	1,300	1,633	1,881	1,540	2,696
EFD 25	0_42523EC	1,000	2,093	2,280	2,730	2,660	4,507
EFD 30	0_43030EC	1,000	2,200	2,695	3,137	2,520	4,668

HOW TO ORDER

OR 4 15 15 EC

Shape code ←
 Ferrite core material ←
 Used for all ferrite types ←
 Approximate length in mm ←
 Approximate width (per set) in mm ←
 Geometry code ←

EFD cores are sold per piece (for sets multiply by 2).
 See page 18 for information on gapped cores.

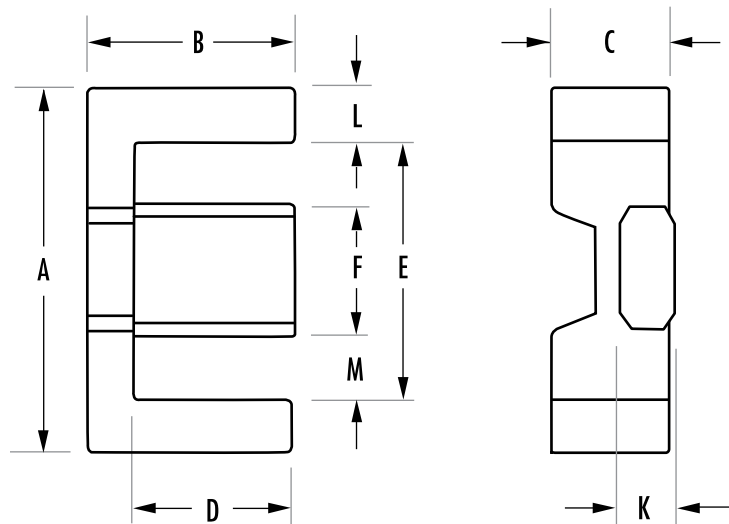

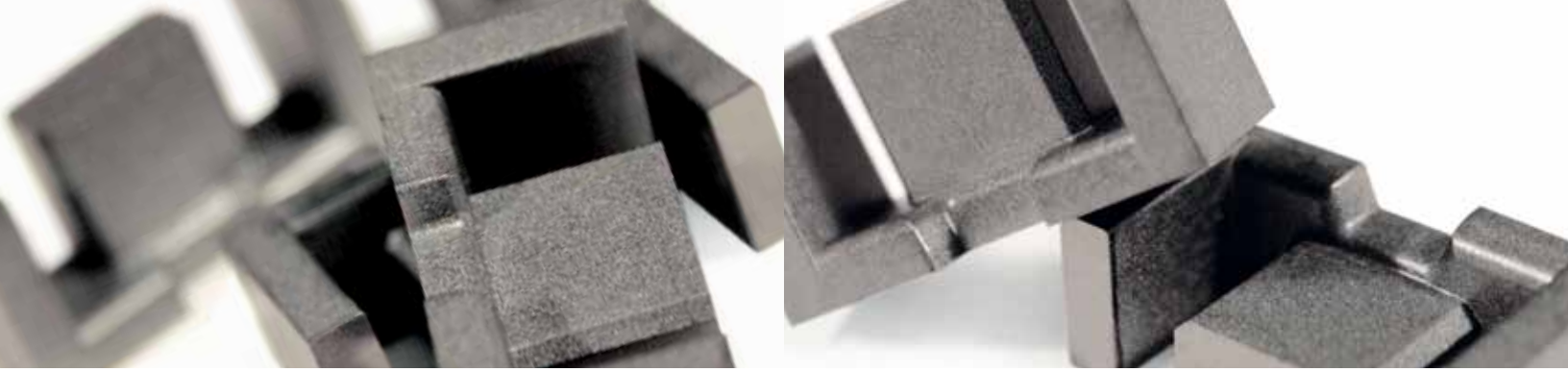

TYPE/SIZE	ORDERING CODE	MAGNETIC DATA						HARDWARE
		I _e (mm)	A _e (mm ²)	A _e min (mm ²)	V _e (mm ³)	WaAc (cm ⁴)	Weight (grams per set)	Bobbins
EFD 10	0_41009EC	23.7	7.2	6.5	171	0.004	0.9	PCB1009B1
EFD 12	0_41212EC	28.5	11.4	10.7	325	0.01	1.8	PCB1212B1
EFD 15	0_41515EC	34.0	15.0	12.2	510	0.02	2.8	PCB1515B1
EFD 20	0_42019EC	47.0	31.0	29.0	1,460	0.09	7.0	PCB2019B1
EFD 25	0_42523EC	57.0	58.0	55.0	3,300	0.24	16.2	PCB2523B1
EFD 30	0_43030EC	68.0	69.0	66.0	4,700	0.34	24.0	PCB3030B1

Refer to page 62 for additional hardware information.

TYPE/SIZE	ORDERING CODE	DIMENSIONS (mm)								
		A	B	C	D	E	F	K	L	M
EFD 10	0_41009EC	10.5 ± 0.3	5.2 ± 0.1	2.7 ± 0.1	3.75 ± 0.15	7.65 ± 0.25	4.55 ± 0.15	4.45 ± 0.05	1.43 ref	1.55 ref
EFD 12	0_41212EC	12.5 ± 0.3	6.2 ± 0.1	3.5 ± 0.1	4.55 ± 0.15	9.0 ± 0.25	5.4 ± 0.15	2.0 ± 0.1	1.75 ref	1.8 ref
EFD 15	0_41515EC	15.0 ± 0.4	7.5 ± 0.15	4.65 ± 0.15	5.5 ± 0.25	11.0 ± 0.35	5.3 ± 0.15	2.4 ± 0.1	2.0 nom	2.85 nom
EFD 20	0_42019EC	20.0 ± 0.55	10.0 ± 0.15	6.65 ± 0.15	7.7 ± 0.25	15.4 ± 0.5	8.9 ± 0.2	3.6 ± 0.15	2.3 ref	3.25 ref
EFD 25	0_42523EC	25.0 ± 0.66	12.5 ± 0.15	9.1 ± 0.2	9.05 min	18.1 min	11.4 ± 0.2	5.2 ± 0.15	3.15 ± 0.2	3.65 ± 0.2
EFD 30	0_43030EC	30.0 ± 0.8	15.0 ± 0.15	9.1 ± 0.2	11.2 ± 0.3	22.4 ± 0.75	14.6 ± 0.25	4.9 ± 0.15	3.8 ref	3.9 ref

ETD Cores

ETD cores are an economical choice for transformers or inductors. ETDs offer a round center leg for minimum winding resistance. Dimensions are optimized for power transformer efficiency.

Typical applications of Magnetics ETD cores include differential mode inductors and power transformers.

TYPE/SIZE	ORDERING CODE	NOMINAL A_L (mH/1000T)				
		L	R	P	F	T
ETD 29	0_42929EC	1,100	2,250	2,843	3,316	
ETD 34	0_43434EC		2,707	2,933	3,600	
ETD 39	0_43939EC		2,973	3,227	4,050	3,650
ETD 44	0_44444EC		3,667	4,000	4,950	4,460
ETD 49	0_44949EC		4,093	4,440	5,400	5,140
ETD 54	0_45454EC		5,200	6,281	7,400	
ETD 59	0_45959EC		5,747	6,240	7,500	7,340
ETD 69	0_47054EC			3,533		

HOW TO ORDER

OR 43939 EC

- Shape code ←
- Ferrite core material ←
- Used for all ferrite types ←
- Approximate length in mm ←
- Approximate height (per set) in mm ←
- Geometry code ←

ETD cores are sold per piece (for sets multiply by 2.)
See page 18 for information on gapped cores.

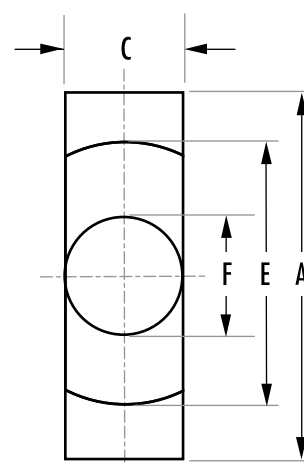
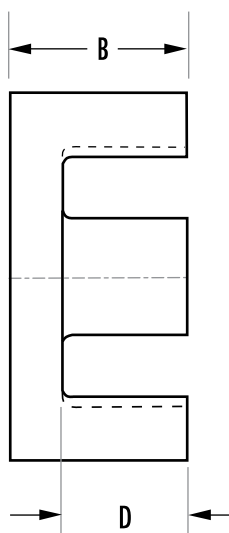

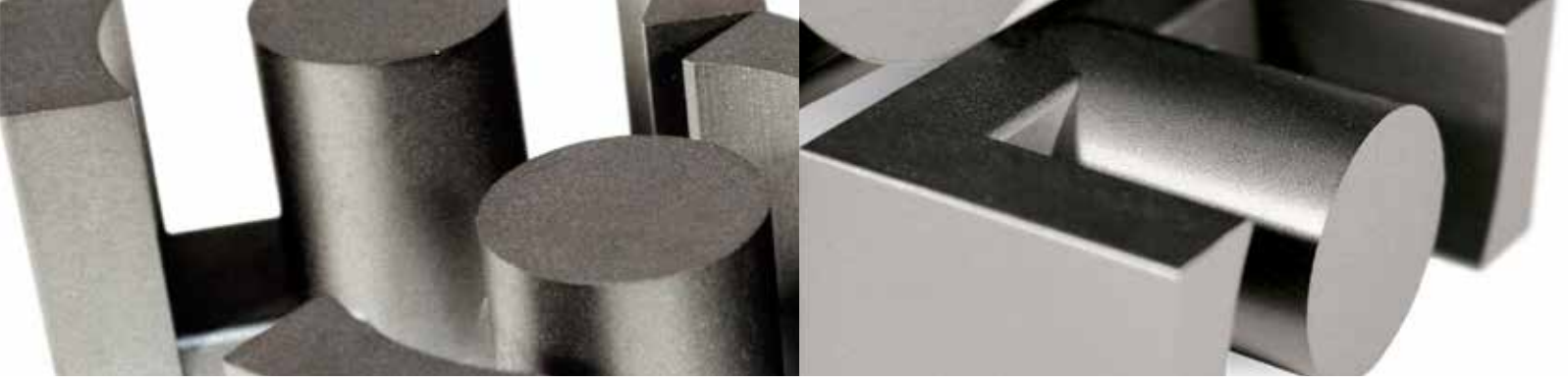

TYPE/SIZE	ORDERING CODE	MAGNETIC DATA						HARDWARE
		I _e (mm)	A _e (mm ²)	A _e min (mm ²)	V _e (mm ³)	WaAc (cm ⁴)	Weight (grams per set)	Bobbins
ETD 29	0_42929EC	72.0	76.0	71.0	5,470	0.71	28	PCB2929B1
ETD 34	0_43434EC	78.6	97.1	91.6	7,640	1.19	40	PCB3434FB
ETD 39	0_43939EC	92.2	125	123	11,500	2.18	60	PCB3939SB
ETD 44	0_44444EC	103	173	172	17,800	3.68	94	PCB444418
ETD 49	0_44949EC	114	211	209	24,000	5.72	124	PCB4949WA
ETD 54	0_45454EC	127	280	280	35,500	8.88	180	PCB5454B1
ETD 59	0_45959EC	139	368	360	51,500	13.7	248	PCB5959AA
ETD 69	0_47054EC	231	334	314	77,100	35.7	371	

Refer to page 62 for additional hardware information.

TYPE/SIZE	ORDERING CODE	DIMENSIONS (mm)					
		A	B	C	D	E	F
ETD 29	0_42929EC	30.6 +0/-1.6	15.8 ± 0.2	9.8 +0/-0.6	11.0 ± 0.3	22.0 +1.4/0	9.8 +0/-0.6
ETD 34	0_43434EC	35.0 +0/-1.6	17.3 ± 0.2	11.1 +0/-0.6	11.8 +0.6/0	25.6 +1.4/0	11.1 +0/-0.6
ETD 39	0_43939EC	40.0 +0/-1.8	19.8 ± 0.2	12.8 +0/-0.6	14.2 +0.8/0	29.3 +1.6/0	12.8 +0/-0.6
ETD 44	0_44444EC	45.0 +0/-2.0	22.3 ± 0.2	15.2 +0/-0.6	16.1 +0.8/0	32.5 +1.6/0	15.2 +0/-0.6
ETD 49	0_44949EC	49.8 +0/-2.2	24.7 ± 0.2	16.7 +0/-0.6	17.7 +0.8/0	36.1 +1.8/0	16.7 +0/-0.6
ETD 54	0_45454EC	54.5 ± 1.3	27.6 ± 0.2	18.9 ± 0.4	20.2 ± 0.4	41.2 ± 1.1	18.9 ± 0.4
ETD 59	0_45959EC	59.8 ± 1.3	31.0 ± 0.2	21.65 ± 0.45	22.1 min	44.7 ± 1.09	21.65 ± 0.45
ETD 69	0_47054EC	68.58 ± 2.1	54.0 ± 0.4	20.0 ± 0.6	41.85 min	54.1 +1.35/-1.6	20.0 ± 0.5

Block Cores

Ferrites can be pressed in block form and then machined into intricate shapes. Where large sizes are required, it is possible to assemble them from two or more smaller machined or pressed sections; the variety of sizes and shapes becomes limitless.

Features of Magnetics ferrite blocks include low porosity, extreme hardness, uniform physical properties, high density and ease of machining. J material offers high permeability; R material is suitable for power applications.

TYPE/SIZE	ORDERING CODE	AVAILABLE MATERIALS				
		L	R	P	F	J
I 11/4/6	O_41106IC		✓	✓	✓	✓
I 12.5/8.5	O_41308IC	✓	✓	✓	✓	
I 18	F_41805IC	✓	✓	✓	✓	
I 20/7/14	F_42014IC	✓	✓	✓	✓	
I 22/4/7	O_42107IC	✓	✓	✓	✓	
I 22	F_42216IC	✓	✓	✓	✓	
I 25/6/6	O_42516IC	✓	✓	✓	✓	✓
I 32	F_43208IC	✓	✓	✓	✓	
I 36/6/18	O_43618IC		✓	✓		
I 38	F_43808IC	✓	✓	✓	✓	
I 40/4/10	O_44008IC		✓	✓	✓	✓
I 43/6/15	O_44020IC		✓	✓		
I 43/4/28	O_44308IC		✓	✓	✓	
I 43	F_44310IC		✓	✓	✓	
I 58	F_45810IC		✓	✓	✓	
I 64	F_46410IC		✓	✓	✓	
I 93/28/16	O_49316IC		✓	✓	✓	✓
I 102/25/25	O_49925IC		✓	✓	✓	
FB 104/66/18	O_49966FB		✓	✓		✓
FB 100/85/25	O_49985FB		✓			
FB 120/120/38	O_49938FB		✓			

HOW TO ORDER

O R 4 99 66 FB

Shape code ←
 Ferrite core material ←
 Used for all ferrite types ←
 Approximate length in mm ←
 Approximate height in mm ←
 Geometry code ←

GEOMETRY CODE

IC – I core

FB – Block core

Block cores and I cores are sold per piece.

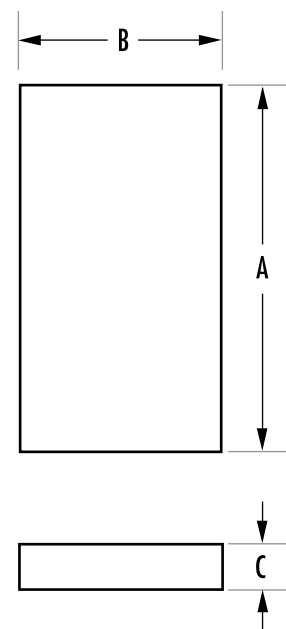



TYPE/SIZE	ORDERING CODE	DIMENSIONS (mm)			Weight (grams per piece)
		A	B	C	
I 11/4/6	O_41106IC	10.8 ± 0.2	1.83 ± 0.12	6.3 ± 0.13	0.7
I 12.5/8.5	O_41308IC	12.8 ± 0.3	1.1 ± 0.1	8.7 ± 0.25	0.6
I 18	F_41805IC	18.0 ± 0.41	2.39 ± 0.1	10.0 ± 0.2	1.8
I 20/7/14	F_42014IC	20.0 ± 0.35	1.9 ± 0.05	14.0 ± 0.3	2.4
I 22/4/7	O_42107IC	21.8 ± 0.4	2.3 ± 0.2	7.8 ± 0.3	2.4
I 22	F_42216IC	21.8 ± 0.4	2.95 ± 0.1	15.8 ± 0.3	4.0
I 25/6/6	O_42516IC	25.4 + 0.64/-0.51	6.35 ± 0.13	6.35 ± 0.13	4.5
I 32	F_43208IC	31.75 ± 0.64	3.18 ± 0.13	20.32 ± 0.41	10.0
I 36/6/18	O_43618IC	35.56 ± 0.05	3.68 ± 0.3	17.8 ± 0.4	11.0
I 38	F_43808IC	38.1 ± 0.76	3.81 ± 0.13	25.4 ± 0.51	18.0
I 40/4/10	O_44008IC	40.64 ± 0.5	4.45 ± 0.25	10.7 ± 0.25	9.0
I 43/6/15	O_44020IC	43.0 + 0/-1.7	5.9 ± 0.2	15.2 + 0/-0.6	19.2
I 43/4/28	O_44308IC	43.2 ± 0.9	4.1 ± 0.13	27.9 ± 0.6	24.0
I 43	F_44310IC	43.2 ± 0.9	4.1 ± 0.13	27.9 ± 0.6	24.0
I 58	F_45810IC	58.42 ± 1.2	4.06 ± 0.12	38.1 ± 0.8	44.0
I 64	F_46410IC	64.0 ± 1.27	5.08 ± 0.13	50.8 ± 1.02	78.0
I 93/28/16	O_49316IC	93.0 ± 1.8	27.5 ± 0.5	16.0 ± 0.6	200
I 102/25/25	O_49925IC	101.6 ± 1.5	25.4 ± 0.4	25.4 ± 0.6	310
FB 104/66/18	O_49966FB	104.0 ± 2	66.0 ± 1.5	18.5 ± 0.4	595
FB 100/85/25	O_49985FB	100.0 ± 2	85.0 ± 2	25.4 ± 0.5	1,065
FB 120/120/38	O_49938FB	120.0 ± 3	120.0 ± 3	38.0 ± 0.5	2,699

EP Cores

EP cores are round center post cubical shapes which enclose the coil completely except for the printed circuit board terminals. This particular shape minimizes the effect of air gaps formed at mating surfaces in the magnetic path and provides a larger volume ratio to total space used. EP cores provide excellent shielding.

Typical applications for EP cores include differential mode and telecom inductors and signal transformers.

TYPE/SIZE	ORDERING CODE	NOMINAL A_L (mH/1000T)						
		L	R	P	F	T	J	W
EP 7	P_40707UG	590	1,080	1,173	1,240		2,573	5,143
EP 10	P_41010UG	530	1,040	1,133	1,200	1,360	2,467	4,800
EP 13	P_41313UG	760	1,533	1,667	2,000	2,000	3,733	7,143
EP 17	P_41717UG	1,120	2,387	2,600	3,100	3,100	5,867	11,429
EP 20	P_42120UG	1,930	4,227	4,600	5,000	5,000	9,600	19,286

HOW TO ORDER

P J 4 10 10 UG

Shape code ←
 Ferrite core material ←
 Used for all ferrite types ←
 Approximate length in mm ←
 Approximate height (per set) in mm ←
 Geometry code ←

EP cores are sold in sets.
 See page 19 for information on gapped cores.

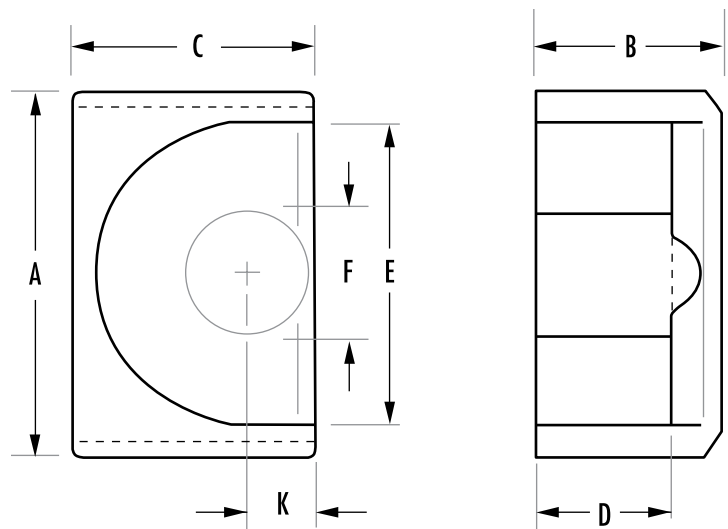

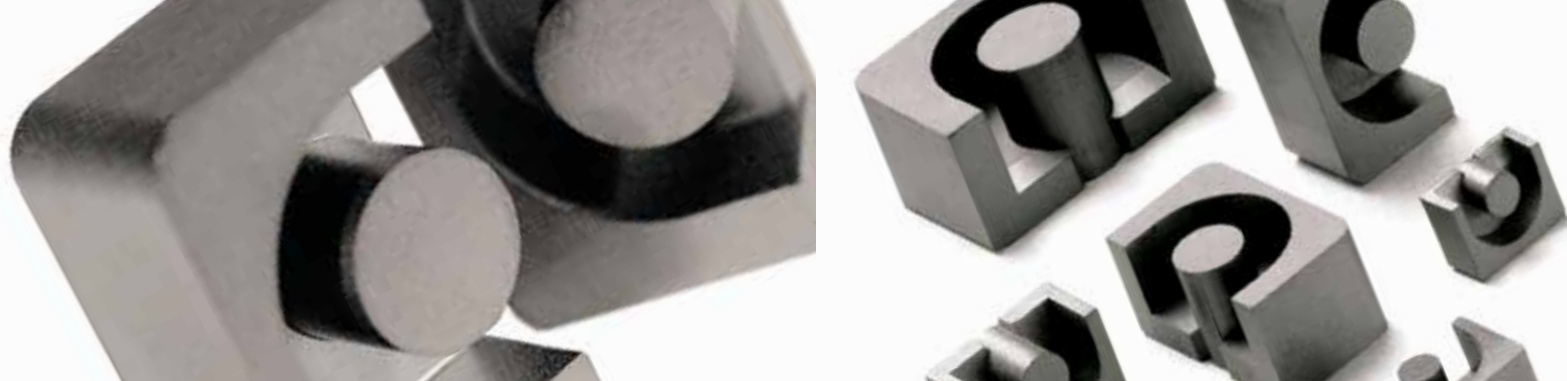

TYPE/SIZE	ORDERING CODE	MAGNETIC DATA						HARDWARE
		I _e (mm)	A _e (mm ²)	A _e min (mm ²)	V _e (mm ³)	WaAc (cm ⁴)	Weight (grams per set)	Bobbins
EP 7	P_40707UG	15.5	10.7	8.55	165	0.005	1.4	SMB07076A
EP 10	P_41010UG	19.3	11.3	8.55	215	0.01	2.8	PCB10108A
EP 13	P_41313UG	24.2	19.5	14.9	472	0.03	5.1	PCB1313B1
EP 17	P_41717UG	29.5	33.7	25.5	999	0.06	11.6	PCB17178A
EP 20	P_42120UG	41.1	78.7	60.8	3,230	0.24	27.6	PCB2120VB

Refer to page 62 for additional hardware information.

TYPE/SIZE	ORDERING CODE	DIMENSIONS (mm)								
		A	B	2B	C	D	2D	E	F	K
EP 7	P_40707UG	9.2 ± 0.2	3.7 ± 0.05	7.4 ± 0.1	6.35 ± 0.15	2.5 min	5.0 min	7.2 min	3.4 max	1.7 ± 0.1
EP 10	P_41010UG	11.5 ± 0.3	5.15 ± 0.1	10.3 ± 0.2	7.6 ± 0.2	3.6 min	7.2 min	9.2 min	3.45 max	1.85 ± 0.1
EP 13	P_41313UG	12.8 +0/-0.6	6.45 ± 0.08	12.9 ± 0.16	9.0 +0/-0.4	4.5 +0.2/-0	9.0 +0.4/-0	9.7 +0.6/-0	4.5 +0/-0.3	2.4 ± 0.1
EP 17	P_41717UG	18.0 ± 0.4	8.4 ± 0.1	16.8 ± 0.2	11.0 ± 0.25	5.7 ± 0.15	11.4 ± 0.3	12.0 ± 0.4	5.7 ± 0.18	3.3 ± 0.2
EP 20	P_42120UG	24.0 ± 0.5	10.7 ± 0.1	21.4 ± 0.2	15.0 ± 0.35	7.2 ± 0.15	14.4 ± 0.3	16.5 ± 0.4	8.8 ± 0.25	4.5 ± 0.2

Pot Cores

Pot cores offer superior shielding and convenient mounting. Typical applications for pot cores include differential mode inductors, power transformers, power inductors, converter and inverter transformers, broadband and narrowband filters, transformers and telecom inductors.

TYPE/SIZE	ORDERING CODE	NOMINAL A_L (mH/1000T)								
		R	P	F	T	J	W	C	E	V
PC 7/4	0_40704UG	886	964	1,200		2,257	4,286		900	950
PC 9/5	0_40905UG	1,013	1,100	1,365		2,727	6,029	640		
PC 11/7	0_41107UG	1,533	1,667	2,000		3,900	7,666	800	1,650	1,800
PC 11/9	0_41109UG	1,467	1,573	1,900						
PC 14/8	0_41408UG	2,053	2,240	2,800	2,800	5,073	8,400	1,100	2,100	2,240
PC 18/11	0_41811UG	3,067	3,333	4,000		7,500	12,000	1,400	3,000	3,650
PC 18/14	0_41814UG	3,076	3,268	3,350		5,088				
PC 22/13	0_42213UG	4,040	4,400	4,900	5,200	9,100	16,000	1,700	3,900	4,650
PC 34/28	0_42438UG			7,550						
PC 26/16	0_42616UG	5,213	5,667	6,350		11,700	20,000			6,000
PC 28/23	0_42823UG			7,000						
PC 30/19	0_43019UG	6,680	7,267	8,100		15,100	25,000	2,800	8,000	7,000
PC 36/22	0_43622UG	8,700	9,467	10,200	10,800	17,500	32,667			9,000
PC 42/29	0_44229UG	9,200	10,000	12,000	11,450		40,000			9,000

HOW TO ORDER

OP 4 14 08 UG

- Shape code ←
- Ferrite core material ←
- Used for all ferrite types ←
- Approximate diameter in mm ←
- Approximate height (per set) in mm ←
- Geometry code ←

Pot cores are sold in sets.
See page 19 for information on gapped cores.

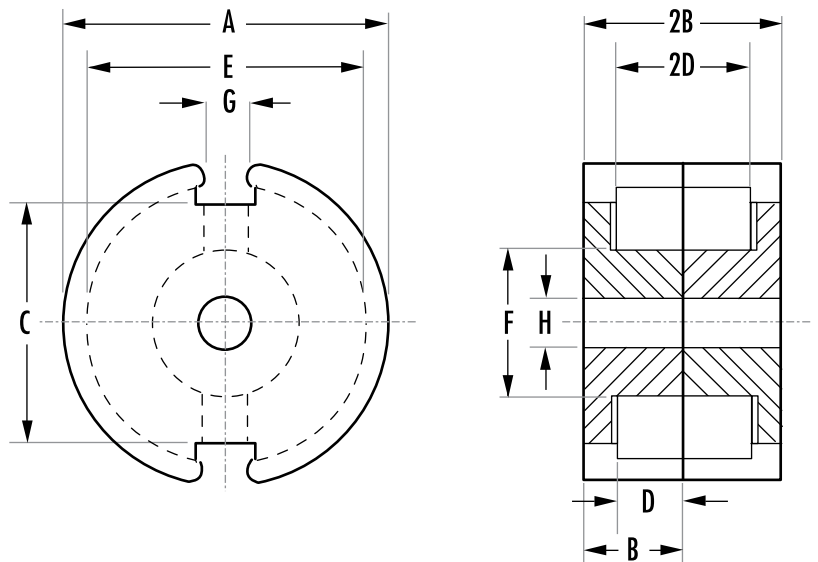



TYPE/SIZE	ORDERING CODE	MAGNETIC DATA						HARDWARE
		I _e (mm)	A _e (mm ²)	A _e min (mm ²)	V _e (mm ³)	WaAc (cm ⁴)	Weight (grams per set)	Bobbins
PC 7/4	O_40704UG	9.9	7.0	5.9	69	0.002	0.5	O0B0704B1
PC 9/5	O_40905UG	12.5	10.1	8.0	126	0.003	0.8	O0B090501
PC 11/7	O_41107UG	15.5	16.2	13.2	251	0.006	1.8	O0B1107B1
PC 11/9	O_41109UG	16.2	16.3	13.2	264	0.01	1.9	
PC 14/8	O_41408UG	19.8	25.1	19.8	495	0.02	3.2	PCB1408TE
PC 18/11	O_41811UG	25.8	43.3	36.0	1,120	0.07	6.4	PCB181111
PC 18/14	O_41814UG	29.3	42.6	36.0	1,248	0.09	7.4	
PC 22/13	O_42213UG	31.5	63.4	50.9	2,000	0.18	13	PCB221311
PC 26/16	O_42616UG	37.6	93.9	77.4	3,530	0.39	20	PCB261611
PC 28/23	O_42823UG	48.1	128	101	6,160	0.58	32	O0B282301
PC 30/19	O_43019UG	45.2	137	116	6,190	0.74	34	PCB301911
PC 34/28	O_43428UG	58.1	159	122	9,230	22.4	47	
PC 36/22	O_43622UG	53.2	202	172	10,700	1.53	57	PCB362211
PC 42/29	O_44229UG	68.6	265	214	18,200	3.68	104	PCB4229L1

Refer to page 62 for additional hardware information.

TYPE/SIZE	ORDERING CODE	DIMENSIONS (mm)									
		A	B	2B	C	D	2D	E	F	G	H
PC 7/4	O_40704UG	7.24 ± 0.15	2.08 ± 0.05	4.16 ± 0.1	4.72 nom	1.4 min	2.79 min	5.74 min	3.0 max	1.52 min	1.09 ± 0.05
PC 9/5	O_40905UG	9.3 + 0/-0.3	2.7 + 0/-0.15	5.4 + 0/-0.3	6.5 ± 0.25	1.8 + 0.15/0	3.6 + 0.3/0	7.5 + 0.25/0	3.9 + 0/-0.2	2.0 ± 0.2	2.04 + 0.06/0
PC 11/7	O_41107UG	11.1 ± 0.2	3.25 ± 0.05	6.5 ± 0.1	6.8 ± 0.25	2.2 + 0.15/0	4.4 + 0.3/0	9.0 + 0.4/0	4.7 + 0/-0.2	2.2 ± 0.3	2.1 ± 0.1
PC 11/9	O_41109UG	11.28 + 0/-0.4	3.43 ± 0.08	6.86 ± 0.16	7.54 ± 0.2	2.48 ± 0.08	4.96 ± 0.16	9.0 + 0.4/0	4.7 + 0/-0.2	1.8 + 0.3/0	2.0 + 0.08/0
PC 14/8	O_41408UG	14.3 + 0/-0.5	4.18 ± 0.06	8.35 ± 0.13	9.5 ± 0.3	2.8 + 0.2/0	5.6 + 0.4/0	11.6 + 0.4/0	6.0 + 0/-0.2	2.7 + 1.2/0	3.1 ± 0.1
PC 18/11	O_41811UG	18.0 ± 0.4	5.3 ± 0.05	10.6 ± 0.1	13.4 ± 0.3	3.7 ± 0.1	7.4 ± 0.2	15.15 ± 0.25	7.45 ± 0.15	3.8 ± 0.6	3.1 ± 0.1
PC 18/14	O_41814UG	18.0 ± 0.4	7.1 ± 0.2	14.2 ± 0.4	11.8 ± 0.25	5.05 + 0.2/0	10.1 + 0.4/0	14.0 + 0.4/0	7.4 + 0/-0.3	3.6 + 0.3/0	3.1 ± 0.08
PC 22/13	O_42213UG	22.0 + 0/-0.8	6.7 ± 0.1	13.4 ± 0.2	15.0 ± 0.4	4.6 + 0.2/0	9.2 + 0.4/0	17.9 + 0.6/0	9.4 + 0/-0.3	3.8 ± 0.6	4.4 + 0.3/0
PC 34/28	O_42438UG	33.7 ± 0.5	13.9 ± 0.2	27.8 ± 0.4	24.8 ± 0.5	10.2 ± 0.15	20.4 ± 0.3	27.5 ± 0.6	13.65 ± 0.3	6.5 ± 0.3	5.56 ± 0.1
PC 26/16	O_42616UG	25.5 ± 0.5	8.05 ± 0.1	16.1 ± 0.2	18.0 ± 0.4	5.5 min	11.0 min	21.6 ± 0.4	11.3 ± 0.2	3.8 ± 0.6	5.5 ± 0.1
PC 28/23	O_42823UG	27.7 ± 0.4	11.43 ± 0.15	22.86 ± 0.3	19.7 nom	8.15 min	16.3 min	22.0 min	12.88 max	3.81 min	5.56 ± 0.1
PC 30/19	O_43019UG	30.0 ± 0.5	9.45 ± 0.05	18.9 ± 0.1	20.5 ± 0.5	6.5 min	13.0 min	25.4 ± 0.4	13.3 ± 0.2	4.3 ± 0.6	5.5 ± 0.1
PC 36/22	O_43622UG	35.6 ± 0.6	10.95 ± 0.05	21.9 ± 0.1	26.2 ± 0.6	7.3 min	14.6 min	30.4 ± 0.5	15.9 ± 0.3	4.9 ± 0.6	5.55 ± 0.15
PC 42/29	O_44229UG	42.4 ± 0.7	14.7 ± 0.05	29.4 ± 0.1	32.0 ± 0.7	10.15 min	20.3 min	36.3 ± 0.7	17.4 ± 0.3	5.1 ± 0.6	5.55 ± 0.15

RS-DS Cores

Slab cores are the same as pot cores except for wider wire openings. A slab piece can be paired with a standard pot core round to make an RS combination, or two slabs can be paired for a double slab (DS).

The RS geometry offers most of the shielding of a pot core but with more space available for terminating leads. DS cores offer a good compromise between shielding and thermal management.

Typical applications for RS and DS combinations include low and medium power transformers, switched-mode power supplies, and multiple output converter and inverter transformers.

TYPE/SIZE	ORDERING CODE	NOMINAL A_L (mH/1000T)				
		R	P	F	J	W
DS 14/08	D 41408UG	1,653	1,800	2,474	3,260	7,929
HS 14/08	H 41408UG	1,533	1,667	1,990	4,107	7,043
RS 14/08	S 41408UG	1,760	1,913	2,274	4,500	7,643
DS 18/11	D 41811UG	3,038	3,236	3,697	5,174	7,386
HS 18/11	H 41811UG	2,666	2,827	3,197	5,140	5,899
RS 18/11	S 41811UG	2,942	3,112	3,498	5,760	6,194
DS 23/11	D 42311UG	3,440	3,747	4,460	8,400	16,064
HS 23/11	H 42311UG	3,200	3,460	4,170	7,853	14,021
RS 23/11	S 42311UG	3,687	4,013	5,200	7,875	16,071
DS 23/18	D 42318UG	2,907	3,160	3,800	6,347	10,000
HS 23/18	H 42318UG	2,600	2,820	3,350	5,333	10,000
RS 23/18	S 42318UG	3,066	3,333	4,000	6,400	12,000
DS 26/16	D 42616UG	3,827	4,160	5,000	8,093	13,000
HS 26/16	H 42616UG	3,630	3,840	4,600	8,107	13,000
RS 26/16	S 42616UG	4,360	4,733	5,300	8,933	15,714
DS 30/19	D 43019UG	4,440	4,827	5,800	9,493	15,000
HS 30/19	H 43019UG	4,227	4,600	5,525	9,507	15,000
RS 30/19	S 43019UG	5,533	6,027	6,700	11,147	18,571
DS 36/22	D 43622UG	5,400	5,827	6,360	9,000	19,000
HS 36/22	H 43622UG	5,200	5,400	6,050	8,550	18,100
RS 36/22	S 43622UG	7,120	7,580	8,660	13,400	26,500
DS 42/29*	D 44229UG	6,500	7,000	7,900	12,200	
RS 42/29	S 44229UG	8,300	8,900	10,400	17,500	

HOW TO ORDER

S P 4 23 11 UG

Shape code ←
 Ferrite core material ←
 Used for all ferrite types ←
 Approximate length in mm ←
 Approximate height (per set) in mm ←
 Geometry code ←

SHAPE CODE

D - DS Core with solid center post
 H - DS Core with center hole
 S - RS core

RS-DS cores are sold in sets.
 See page 19 for information on gapped cores.
 *For DS 42/29 size, see datasheets for differences in geometry.

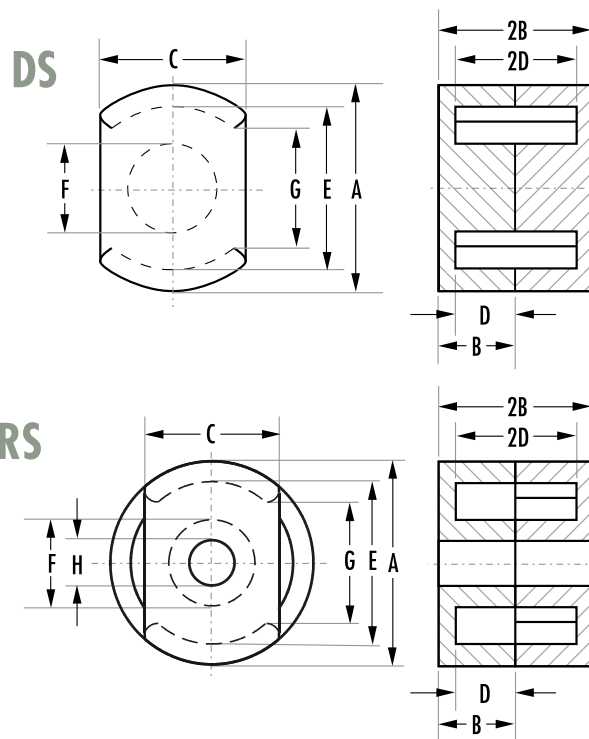

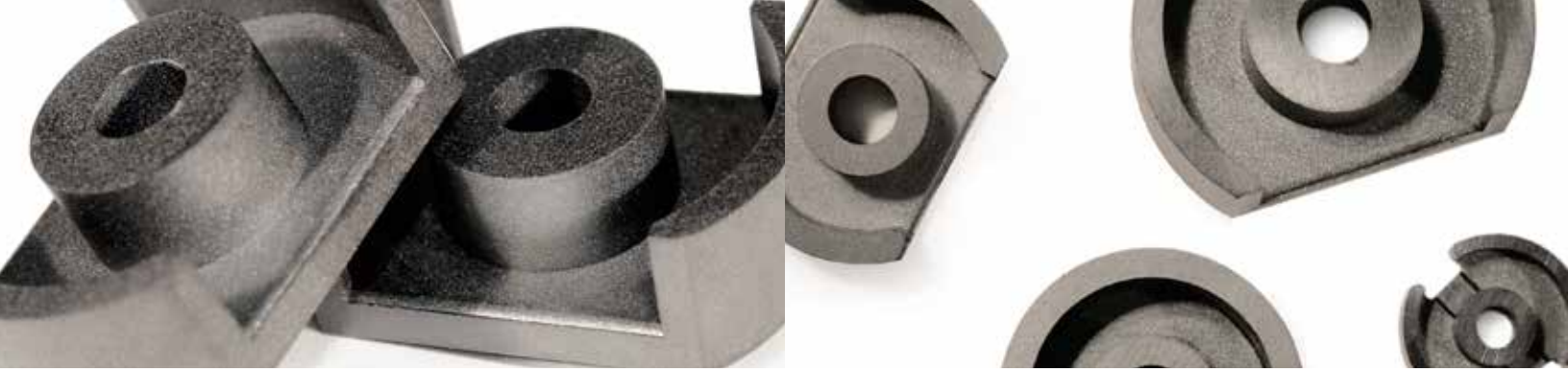

TYPE/SIZE	ORDERING CODE	MAGNETIC DATA						HARDWARE
		I _e (mm)	A _e (mm ²)	A _e min (mm ²)	V _e (mm ³)	WaAc (cm ⁴)	Weight (grams per set)	Bobbins
DS 14/08	D 41408UG	22.6	24.6	23.5	556	0.02	3.4	PCB1408TE
HS 14/08	H 41408UG	20.6	21.0	19.2	433	0.02	2.6	PCB1408TE
RS 14/08	S 41408UG	20.2	23.0	19.2	460	0.02	2.8	PCB1408TE
DS 18/11	D 41811UG	29.1	40.0	36.3	1,167	0.07	7.1	PCB181111
HS 18/11	H 41811UG	28.7	37.2	31.0	1,070	0.05	6.6	PCB181111
RS 18/11	S 41811UG	27.2	40.6	32.9	1,110	0.07	6.8	PCB181111
DS 23/11	D 42311UG	26.8	51.2	37.8	1,370	0.08	10.0	PCB2311TA
HS 23/11	H 42311UG	27.0	48.2	37.8	1,300	0.08	9.1	PCB2311TA
RS 23/11	S 42311UG	28.6	61.0	53.6	1,740	0.10	10.5	PCB2311TA
DS 23/18	D 42318UG	39.9	58.0	40.7	2,310	0.21	13.0	PCB2318TA
HS 23/18	H 42318UG	40.1	53.4	40.7	2,130	0.20	12.1	PCB2318TA
RS 23/18	S 42318UG	41.6	62.2	53.6	2,590	0.22	14.0	PCB2318TA
DS 26/16	D 42616UG	38.9	77.0	62.7	3,000	0.32	15.0	PCB261611
HS 26/16	H 42616UG	39.0	72.1	62.7	2,810	0.30	14.4	PCB261611
RS 26/16	S 42616UG	38.3	82.6	62.7	3,180	0.35	15.5	PCB261611
DS 30/19	D 43019UG	49.5	120	111	5,940	0.63	31.0	PCB301911
HS 30/19	H 43019UG	46.1	111	96.0	5,110	0.60	26.0	PCB301911
RS 30/19	S 43019UG	45.6	123	96.0	5,610	0.67	30.5	PCB301911
DS 36/22	D 43622UG	56.9	162	140	9,250	1.22	47.6	PCB362211
HS 36/22	H 43622UG	57.6	157	140	9,030	1.19	46.3	PCB362211
RS 36/22	S 43622UG	55.4	179	140	9,944	1.36	51.0	PCB362211
DS 42/29	D 44229UG	76.0	232	211	17,600	3.22	90.5	PCB4229L1
RS 42/29	S 44229UG	72.3	244	211	17,641	3.35	90.6	PCB4229L1

Refer to page 62 for additional hardware information.

TYPE/SIZE	ORDERING CODE	DIMENSIONS (mm)									
		A	B	2B	C	D	2D	E	F	G	H
DS 14/08	D 41408UG	14.05 ± 0.25	4.15 ± 0.08	8.3 ± 0.15	9.4 ± 0.15	2.9 ± 0.1	5.8 ± 0.2	11.8 ± 0.2	5.9 ± 0.1	7.6 min	
HS 14/08	H 41408UG	14 ± 0.25	4.24 + 0/-0.13	8.48 + 0/-0.26	9.4 ± 0.15	2.8 min	5.58 min	11.6 min	5.99 max	7.6 min	3.1 ± 0.1
RS 14/08	S 41408UG	14 ± 0.25	4.24 + 0/-0.13	8.48 + 0/-0.26	9.4 ± 0.15	2.8 min	5.58 min	11.6 min	5.99 max	7.6 min	3.1 ± 0.1
DS 18/11	D 41811UG	18 ± 0.4	5.3	10.6 ± 0.15	11.9 ± 0.2	3.7	7.4 ± 0.2	15.15 ± 0.25	7.45 ± 0.15	11.2 min	
HS 18/11	H 41811UG	18 ± 0.4	5.3 ± 0.07	10.6 ± 0.15	11.9 ± 0.2	3.7 ± 0.1	7.4 ± 0.2	15.15 ± 0.25	7.45 ± 0.15	11.2 min	3.1 ± 0.1
RS 18/11	S 41811UG	18 ± 0.4	5.3 ± 0.07	10.6 ± 0.15	11.9 ± 0.2	3.7 ± 0.1	7.4 ± 0.2	15.15 ± 0.25	7.45 ± 0.15	11.2 min	3.1 ± 0.1
DS 23/11	D 42311UG	22.86 ± 0.46	5.54 ± 0.13	11.08 ± 0.26	15.24 ± 0.25	3.63 min	7.26 min	17.93 min	9.9 max	13.21 min	
HS 23/11	H 42311UG	22.86 ± 0.46	5.54 ± 0.13	11.08 ± 0.26	15.24 ± 0.25	3.63 min	7.26 min	17.93 min	9.9 max	13.21 min	5.1 ± 0.1
RS 23/11	S 42311UG	22.9 ± 0.45	5.5 ± 0.13	11 ± 0.25	15.2 ± 0.25	3.75 ± 0.13	7.5 ± 0.25	18.3 ± 0.35	9.7 ± 0.2	13.2 min	5.1 ± 0.1
DS 23/18	D 42318UG	22.86 ± 0.46	9 ± 0.18	18 ± 0.36	15.24 ± 0.25	6.93 min	13.86 min	17.93 min	9.9 max	13.21 min	
HS 23/18	H 42318UG	22.86 ± 0.46	9 ± 0.18	18 ± 0.36	15.24 ± 0.25	6.93 min	13.86 min	17.93 min	9.9 max	13.2 min	5.08 ± 0.1
RS 23/18	S 42318UG	22.9 ± 0.45	9 ± 0.18	18 ± 0.35	15.25 ± 0.25	7.2 ± 0.18	14.4 ± 0.35	18.3 ± 0.35	9.7 ± 0.2	13.2 min	5.1 ± 0.1
DS 26/16	D 42616UG	25.5 ± 0.51	8.05 ± 0.1	16.1 ± 0.2	17.09 nom	5.51 min	11.02 min	21.21 min	11.48 max	15.5 min	
HS 26/16	H 42616UG	25.5 ± 0.51	8.05 ± 0.1	16.1 ± 0.2	17.09 nom	5.51 min	11.02 min	21.21 min	11.48 max	15.5 min	5.56 ± 0.1
RS 26/16	S 42616UG	25.5 ± 0.51	8.05 ± 0.1	16.1 ± 0.2	17.09 nom	5.51 min	11.02 min	21.21 min	11.48 max	15.5 min	5.56 ± 0.1
DS 30/19	D 43019UG	30 ± 0.51	9.4 ± 0.1	18.8 ± 0.2	20.3 ± 0.25	6.5 min	13 min	25 min	13.51 max	15.49 min	
HS 30/19	H 43019UG	30 ± 0.51	9.4 ± 0.1	18.8 ± 0.2	20.32 ± 0.25	6.5 min	13 min	25 min	13.51 max	15.49 min	5.56 ± 0.1
RS 30/19	S 43019UG	30 ± 0.51	9.4 ± 0.1	18.8 ± 0.2	20.32 ± 0.25	6.5 min	13 min	25 min	13.51 max	15.49 min	
DS 36/22	D 43622UG	35.61 ± 0.51	10.85 ± 0.12	21.7 ± 0.25	23.85 nom	7.29 min	14.58 min	29.9 min	16.1 max	20.3 min	
HS 36/22	H 43622UG	35.61 ± 0.51	10.85 ± 0.12	21.7 ± 0.25	23.85 nom	7.29 min	14.58 min	29.85 min	16.1 max	20.3 min	5.56 ± 0.1
RS 36/22	S 43622UG	35.61 ± 0.51	10.9 ± 0.07	21.8 ± 0.15	23.85 nom	7.4 ± 0.1	14.8 ± 0.2	29.9 min	16.1 max	20.3 min	
DS 42/29	D 44229UG	42.4 ± 0.71	14.8 ± 0.2	29.6 ± 0.4	28.4 nom	10.21 min	20.42 min	35.61 min	17.7 max	25.0 min	
RS 42/29	S 44229UG	42.4 ± 0.71	14.8 ± 0.2	29.6 ± 0.4	28.4 nom	10.21 min	20.42 min	35.61 min	17.7 max	25.0 min	5.56 ± 0.1

PQ Cores

PQ cores are designed specifically for switched mode power supplies. One result is an optimized ratio of volume to winding area and surface area, meaning that maximum inductance and winding area are possible with a minimum core size. The cores provide maximum power output with minimum assembled transformer weight and volume, in addition to taking up a minimum amount of area on the printed circuit board.

Assembly with printed circuit bobbins and one piece clamps is simplified. PQs provide a more uniform cross-sectional area, so they tend to operate with less pronounced hot spots than most other cores.

Typical applications include power transformers and power inductors.

TYPE/SIZE	ORDERING CODE	NOMINAL A_L (mH/1000T)				
		L	R	P	F	T
PQ 20/16	0_42016UG	1,650	3,587	3,907	4,690	4,080
PQ 20/20	0_42020UG	1,300	2,947	3,213	3,860	3,580
PQ 26/10	0_42610UG	3,900	7,733	8,413	8,080	
PQ 26/14	0_42614UG	2,700	5,613	6,113	7,335	
PQ 26/20	0_42620UG	2,640	5,560	6,053	7,270	7,020
PQ 26/25	0_42625UG	2,200	4,600	5,000	6,010	6,010
PQ 32/12	0_43214UG		6,867	7,467	8,960	
PQ 32/20	0_43220UG		6,640	7,213	8,875	7,560
PQ 32/30	0_43230UG		4,667	5,080	6,100	6,570
PQ 35/35	0_43535UG		4,813	5,240	7,347	6,000
PQ 40/40	0_44040UG		4,267	4,640	5,580	6,100
PQ 50/50	0_45050UG		7,400	8,195	9,639	9,200

HOW TO ORDER

OR 4 20 16 UG

- Shape code ←
- Ferrite core material ←
- Used for all ferrite types ←
- Approximate length in mm ←
- Approximate height (per set) in mm ←
- Geometry code ←

PQ cores are sold in sets.
 For clip slot dimensions see individual data sheets.
 See page 19 for information on gapped cores.

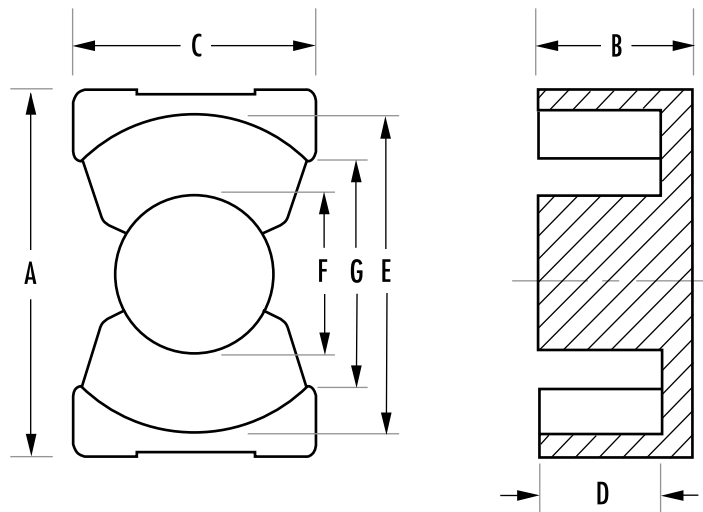



		MAGNETIC DATA						HARDWARE
TYPE/SIZE	ORDERING CODE	I_e (mm)	A_e (mm ²)	A_e min (mm ²)	V_e (mm ³)	WaAc (cm ⁴)	Weight (grams per set)	Bobbins
PQ 20/16	0_42016UG	37.6	61.9	59.1	2,330	0.17	13	PCB2016FC
PQ 20/20	0_42020UG	45.7	62.6	59.1	2,850	0.23	16	PCB2020FB
PQ 26/10	0_42610UG	29.4	105	93.8	3,090	0.07	17	
PQ 26/14	0_42614UG	33.3	86.4	70.9	2,880	0.17	16	
PQ 26/20	0_42620UG	45.0	121	109	5,470	0.40	31	PCB2620LB
PQ 26/25	0_42625UG	54.3	120	108	6,530	0.60	36	PCB2625LB
PQ 32/12	0_43214UG	34.4	109	92.0	3,750	0.29	21	
PQ 32/20	0_43220UG	55.9	169	142	9,440	0.79	42	PCB3220B1
PQ 32/30	0_43230UG	74.7	167	142	12,500	1.66	57	PCB3230B1
PQ 35/35	0_43535UG	86.1	190	162	16,300	3.02	73	PCB3535LB
PQ 40/40	0_44040UG	102	201	175	20,500	4.84	97	PCB4040FA
PQ 50/50	0_45050UG	113	328	314	37,100	8.28	195	00B5050B1

Refer to page 62 for additional hardware information.

		DIMENSIONS (mm)								
TYPE/SIZE	ORDERING CODE	A	B	2B	C	D	2D	E	F	G
PQ 20/16	0_42016UG	21.3 ± 0.4	8.1 ± 0.1	16.2 ± 0.2	14.0 ± 0.4	5.15 ± 0.15	10.3 ± 0.3	18.0 ± 0.4	8.8 ± 0.2	12.0 min
PQ 20/20	0_42020UG	21.3 ± 0.4	10.1 ± 0.1	20.2 ± 0.2	14.0 ± 0.4	7.15 ± 0.15	14.3 ± 0.3	18.0 ± 0.4	8.8 ± 0.2	12.0 min
PQ 26/10	0_42610UG	27.2 ± 0.45	5.1 ± 0.1	10.2 ± 0.2	19.0 ± 0.45	1.2 min	2.39 min	22.05 min	12.2 max	15.5 min
PQ 26/14	0_42614UG	27.2 ± 0.45	5.94 ± 0.1	11.9 ± 0.2	19.0 ± 0.45	3.4 min	6.7 min	22.05 min	12.2 max	15.5 min
PQ 26/20	0_42620UG	27.3 ± 0.46	10.1 ± 0.13	20.2 ± 0.25	19.0 ± 0.45	5.75 ± 0.15	11.5 ± 0.3	22.5 ± 0.45	12.0 ± 0.2	15.5 min
PQ 26/25	0_42625UG	27.3 ± 0.46	12.35 ± 0.13	24.7 ± 0.25	19.0 ± 0.45	8.05 ± 0.15	16.1 ± 0.3	22.5 ± 0.46	12.0 ± 0.2	15.5 min
PQ 32/12	0_43214UG	33.0 ± 0.5	5.94 ± 0.1	11.9 ± 0.2	22.0 ± 0.5	3.4 min	6.7 min	27.0 min	13.75 max	19.0 min
PQ 32/20	0_43220UG	33.0 ± 0.5	10.3 ± 0.13	20.6 ± 0.25	22.0 ± 0.5	5.75 ± 0.15	11.5 ± 0.3	27.5 ± 0.5	13.5 ± 0.25	19.0 min
PQ 32/30	0_43230UG	33.0 ± 0.5	15.15 ± 0.13	30.3 ± 0.25	22.0 ± 0.5	10.65 ± 0.15	21.3 ± 0.3	27.5 ± 0.5	13.5 ± 0.25	19.0 min
PQ 35/35	0_43535UG	36.1 ± 0.6	17.35 ± 0.13	34.7 ± 0.25	26.0 ± 0.5	12.5 ± 0.15	25.0 ± 0.3	32.0 ± 0.5	14.4 ± 0.25	23.5 min
PQ 40/40	0_44040UG	41.5 ± 0.9	19.9 ± 0.15	39.8 ± 0.3	28.0 ± 0.6	14.75 ± 0.2	29.5 ± 0.4	37.0 ± 0.6	14.9 ± 0.3	29.0 ± 1.0
PQ 50/50	0_45050UG	51.0 ± 0.7	25.0 ± 0.25	50.0 ± 0.5	32.0 ± 0.6	18.05 ± 0.3	36.1 ± 0.6	44.0 ± 0.7	20.0 ± 0.35	32.0 min

RM Cores

RM cores are designed for wound assemblies with a square footprint for efficient use of PC board space. The wire openings allow space for multiple coil terminations and offer a balance between shielding and thermal performance.

Easy to assemble and adaptable to automation, completed units provide at least 40% savings in mounting area compared to a similar size pot core assembly.

Typical applications include differential mode inductors, power inductors, filter inductors, telecom inductors and broadband transformers.

TYPE/SIZE	ORDERING CODE	NOMINAL A_L (mH/1000T)								
		L	R	P	F	T	J	W	C	V
RM 4 N	N_41110UG	560	1,125	1,191	1,333		1,752	3,518		
RM 4	R_41110UG		920	1,000	1,200		1,973	3,000		
RM 5 N	N_41510UG	900	1,720	1,867	2,100		4,133	6,000		
RM 5	R_41510UG		1,720	1,867	2,100		4,133	6,000	800	1,960
RM 6R N	N_41812UG	1,230	2,387	2,600	3,080	2,830	6,707	8,600		
RM 6R	R_41812UG		2,187	2,333	2,800		5,973	7,714		2,700
RM 6S N	N_41912UG	1,250	2,213	2,400	2,880		6,000	8,600		
RM 6S	R_41912UG		1,987	2,160	2,600		5,387	7,714		
RM 7 N	N_42013UG	1,450	3,058	3,244	3,675		5,001	9,571		
RM 8 N	N_42316UG	1,700	2,700	2,933	5,210	4,100	8,000	12,200		
RM 8	R_42316UG		2,347	2,560	3,500		6,960	10,600		
RM 10 N	N_42819UG	2,200	4,047	4,400	5,500	5,500	9,987	16,000		
RM 10	R_42819UG				4,750					
RM 12 N	N_43723UG		4,600	5,000	6,000	6,790	11,800	22,600		
RM 14 N	N_44230UG		7,000	7,540	8,782	8,130	13,096	20,735		

HOW TO ORDER

R P 4 15 10 UG

Shape code ←
 Ferrite core material ←
 Used for all ferrite types ←
 Approximate diameter in mm ←
 Approximate height (per set) in mm ←
 Geometry code ←

SHAPE CODE

N — RM core with solid center post
 R — RM core with center hole

RM cores are sold in sets.
 See page 19 for information on gapped cores.

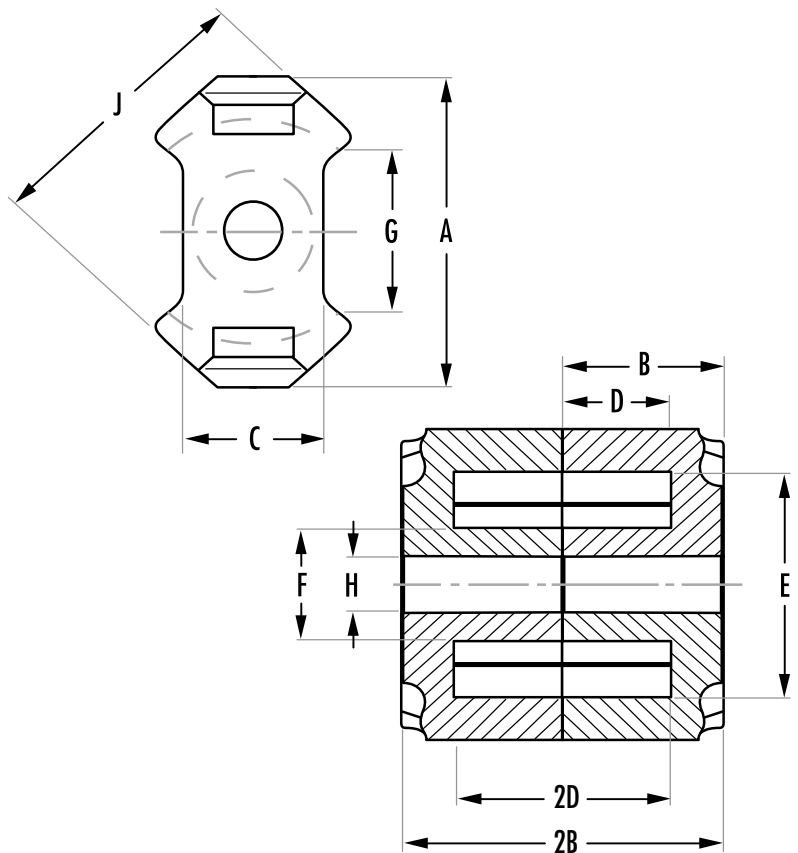



TYPE/SIZE	ORDERING CODE	MAGNETIC DATA						HARDWARE
		I_e (mm)	A_e (mm ²)	A_e min (mm ²)	V_e (mm ³)	WaAc (cm ⁴)	Weight (grams per set)	Bobbins
RM 4 N	N_41110UG	23.3	13.8	11.5	322	0.01	1.7	PCB11104B
RM 4	R_41110UG	20.6	10.8	7.9	222	0.01	1.5	PCB11104B
RM 5 N	N_41510UG	23.2	24.8	18.1	574	0.02	3.2	PCB1510B1
RM 5	R_41510UG	21.4	21.0	13.9	449	0.02	3.1	PCB1510B1
RM 6R N	N_41812UG	27.5	38.0	31.2	1,040	0.06	5.4	OOC1812B1
RM 6R	R_41812UG	25.6	32.0	22.6	819	0.05	4.5	OOC1812B1
RM 6S N	N_41912UG	29.2	37.0	31.2	1,090	0.06	5.5	
RM 6S	R_41912UG	27.0	31.0	22.6	837	0.05	5.1	
RM 7 N	N_42013UG	30.0	44.1	39.6	1,325	0.17	7.5	
RM 8 N	N_42316UG	38.4	63.0	55.4	2,440	0.19	13	OOC2316B1
RM 8	R_42316UG	35.5	52.0	36.9	1,850	0.16	11	OOC2316B1
RM 10 N	N_42819UG	44.6	96.6	89.1	4,310	0.44	22	OOC2819B1
RM 10	R_42819UG	41.7	83.2	65.3	3,470	0.41	18	OOC2819B1
RM 12 N	N_43723UG	56.6	146	125	8,340	1.07	46	PCB3723M1
RM 14 N	N_44230UG	70.0	198	168	13,900	1.73	69	

Refer to page 62 for additional hardware information.

TYPE/SIZE	ORDERING CODE	DIMENSIONS (mm)										
		A	B	2B	C	D	2D	E	F	G	H	J
RM 4 N	N_41110UG	11.0+0/-0.5	5.2±0.05	10.4±0.1	4.6+0/-0.2	3.5+0.2/-0	7.0+0.4/-0	7.95+0.4/-0	3.9+0/-0.2	5.8 min		9.8+0/-0.4
RM 4	R_41110UG	11.8 max	5.2±0.05	10.4±0.1	4.45 nom	3.61±0.1	7.21±0.2	8.15±0.2	3.8±0.1	5.79 ref	2.05±0.05	9.6±0.2
RM 5 N	N_41510UG	14.6+0/-0.6	5.2±0.05	10.4±0.1	6.8+0/-0.4	3.25±0.1	6.5±0.2	10.2+0.4/-0	4.9+0/-0.2	6.0 min		12.3+0/-0.5
RM 5	R_41510UG	14.9 max	5.2±0.05	10.4±0.1	6.6 nom	3.25±0.1	6.5±0.2	10.4±0.2	4.8±0.1	6.71 nom	2.05±0.05	12.05±0.25
RM 6R N	N_41812UG	17.9+0/-0.7	6.2±0.05	12.4±0.1	7.4+0/-0.4	4.0+0.2/-0	8.0+0.4/-0	12.4+0.5/-0	6.4+0/-0.2	5.85 nom		14.7+0/-0.6
RM 6R	R_41812UG	18.3 max	6.2±0.05	12.4±0.1	7.4 nom	4.1±0.1	8.2±0.2	12.65±0.25	6.25±0.15	5.85 nom	3.05±0.05	14.4±0.3
RM 6S N	N_41912UG	18.3 max	6.2±0.05	12.4±0.1	8.2 nom	4.1±0.1	8.2±0.2	12.65±0.25	6.25±0.15	9.0 nom		14.4±0.3
RM 6S	R_41912UG	18.3 max	6.2±0.05	12.4±0.1	8.2 nom	4.1±0.1	8.2±0.2	12.65±0.25	6.25±0.15	9.0 nom	3.05±0.05	14.4±0.3
RM 7 N	N_42013UG	20.3+0/-0.8	6.7±0.05	13.4±0.1	7.25+0/-0.3	4.2+0.25/-0	8.4+0.5/-0	14.75+0.6/-0	7.25+0/-0.3	9.3 min		17.2+0/-0.7
RM 8 N	N_42316UG	23.2+0/-0.9	8.2±0.05	16.4±0.1	11.0+0/-0.5	5.5±0.1	11.0±0.2	17.0+0.6/-0	8.55+0/-0.3	9.5 min		19.7+0/-0.8
RM 8	R_42316UG	23.2 max	8.2±0.05	16.4±0.1	10.8 nom	5.53±0.13	11.05±0.25	17.5±0.35	8.4±0.15	11.7 nom	4.5±0.1	19.3±0.4
RM 10 N	N_42819UG	28.5+0/-1.3	9.3±0.05	18.6±0.1	13.5+0/-0.5	6.2+0.3/-0	12.4+0.6/-0	21.2+0.9/-0	10.9+0/-0.4	10.9 min		24.7+0/-1.1
RM 10	R_42819UG	28.5+0/-1.3	9.3±0.05	18.6±0.1	13.5+0/-0.5	6.2+0.3/-0	12.4+0.6/-0	21.2+0.9/-0	10.9+0/-0.4	10.9 min	5.4+0.2/-0	24.7+0/-1.1
RM 12 N	N_43723UG	37.4+0/-1.3	12.25±0.05	24.5±0.1	16.1+0/-0.5	8.4+0.3/-0	16.8+0.6/-0	24.9+1.1/-0	12.8+0/-0.4	12.9 min		29.8+0/-1.1
RM 14 N	N_44230UG	42.2+0/-1.4	15.05±0.05	30.1±0.1	19.0+0/-0.6	10.4+0.3/-0	20.8+0.6/-0	29.0+1.2/-0	15.0+0/-0.6	17.0 nom		34.8+0/-1.3

Hardware



SIZE	TYPE	P/N	SIZE	TYPE	P/N	SIZE	TYPE	P/N	SIZE	TYPE	P/N	SIZE	TYPE	P/N	SIZE	TYPE	P/N
0200	TC	SMC06018A	1408	PC	O0B140801	1912	RM	PCB181241	2507	TC	TVB2908TA	3113	TC	TVB2908TA	4119	EC	PCH411901
		SMH05025A		RS/DS	O0B140802			PCB181261			TVH22064A			TVB3610FA	4216	EER	PCB4216FA
		SMH07058A			O0C140811			TBA181201			TVH25074A	3205	TC	TVB3610FA	4229	PC	O0B422901
0301	TC	SMC06018A			O0W140815			TCA1812C2	2508	TC	TVB2908TA			TVH38134A			O0B422902
		SMH05025A			PCB140821	2016	PQ	O0C201612			TVH22064A	3208	P-EC	O0C320802			O0C422917
		SMH07058A			PCB1408S1			PCB2016FC			TVH25074A	3220	PQ	O0C322017			PCB4229L1
0401	TC	SMC06018A			PCB1408TA	2019	EFD	O0C2019B1	2510	EC	O0B251001			PCB3220B1			TBP669000
		SMH05025A			PCB1408TB			PCB2019B1			PCB2510V1	3230	PQ	O0C323017			TCF2800B1
		SMH07058A			PCB1408TE	2020	PQ	O0C202012			PCB2510V2			PCB3230B1			TCF4000B1
0402	TC	SMC06018A			TBA140800			PCB2020FC	2515	EC-EC	O0B251501	3434	ETD	O0C343416	4317	EC	PCB4317M1
		SMH05025A			TCA1408B1	2106	TC	TVB22066A	2520	EC	PCB2520TA			PCB3434FB			O0B4317B1
		SMH07058A			TCA1408C3			TVB2908TA	2523	EFD	O0C2523B1	3515	EC	O0B351501	4416	TC	TVH49164A
0502	TC	SMC06018A	1450	TC	TVB22066A			TVH22064A			PCB2523B1			PCB3515M1	4444	ETD	O0C444416
		SMH05025A			TVH22064A	1506	TC	TVB22066A	2616	PC	O0B261601			PCB3515M2			PCB444418
		SMH07058A			TVH22064A			TVH25074A		RS/DS	O0B261602	3517	EC	OAC351717	4715	TC	TVH49164A
0503	TC	SMC06018A			TVH22064A	2109	TC	TVB22066A			O0B261603			OCC351700	4721	EC	PCB4721M1
		SMH05025A			TVH22064A			TVB2908TA			O0C261614			PCB351701	4916	TC	TVH49164A
		SMH07058A			TVH22064A			TVH22064A			OPC261614			PCH351701	4920	TC	TVH49164A
0601	TC	SMC06018A			PCB1510B1	2120	EP	OAC212016			PCB261611	3521	EER	PCB3521LA	4925	TC	TVH49164A
		SMH07058A			TBP151000			OBC212016	2206	TC	PCB261612	3535	PQ	O0C353517	4932	TC	TVH49164A
0603	TC	SMC06018A	1515	EFD	SMB1515TA			PCB2120VB			PCB261613	3610	TC	PCB3535LB	4949	ETD	O0C494916
		SMH07058A			O0C1515B1			TVB22066A			PCB261621	3615	TC	TVH38134A			PCB494920
		SMH07058A			PCB1515B1	1605	TC	TVB22066A	2207	TC	PCB261622	3622	PC	TVH38134A	5050	PQ	O0B5050B1
0704	PC	O0B070401			TVB22066A			TVH22064A			PCB2616TA			TVH38134A	5224	EC	OAC522423
		O0B0704B1			TVH22064A	1717	EP	O0C17172A			TBP669000	3622	PC	O0B362201			OAC522400
0705	TC	SMH07058A			TVH22064A			TVH25074A	2620	PQ	O0C262012			O0C362217			PCB522401
0707	EP	OAC070716			TVH22064A			TVB2908TA			PCB2620LB			PCB362211			PCH522401
		OBC070712			TVH22064A			TVH22064A	2625	PQ	O0C262512			PCB3622L1			O0B5224B1
		SMB07076A			TVH22064A			TVH25074A			PCB2625LB			TBP669000			TCF2800B1
0905	PC	O0B090501	1805	P-EC	O0C180520			TVB2908TA	2819		O0C2819B1	3723	RM	PCB3723M1	5454	ETD	O0C5454B1
0906	ER	O0C09061A	1808	EC	O0B180801			TVH22066A	2823	PC	O0B282301	3806	TC	TVB3610FA	5528	EC	O0B5528B1
		SMB09068A			PCB1808B1	2212	TC	TVB22066A	2908	TC	TVB2908TA			TVH38134A			PCB5528WC
1009	EFD	O0C1009B1	1809	TC	TVB22066A			TVB2908TA			TVB3610FA	3813	TC	TVH38134A	5530	EC	PCB5530FA
		PCB1009B1			TVH22064A			TVH22064A	2915	TC	TVB2908TA			TVH38134A	5724	EC	O0B5724B1
1010	EP	O0C10102A	1811	PC	O0B181101			TVH25074A			TVH25074A			TVH49164A	5810	EC-IC	O0C581001
		PCB10108A		RS/DS	O0B181102	2213	PC	O0B221301			TVB2908TA			TVH38134A			O0C581002
		SMB10108A			O0C181103			O0B221302	2929	ETD	O0C2929B1	3825	TC	TVB3610FA	5959	ETD	O0C595916
1107	PC	O0B1107B1			O0C181111			O0C221314			PCB2929B1			TVH49164A			PCB5959AA
		O0B1107A2			O0W181118			O0W221324	3007	EC	PCB3007T1	3939	ETD	O0C393916	6113	TC	TVH49164A
		O0C1107B1			PCB181111			OPC221314	3009	EC	PCB3009LA			PCB3939SB			TVH61134A
1110	RM	O0C1110B1			PCB181112			PCB221311	3019	PC	O0B301901	4015	TC	TVH49164A	6326	TC	TVH49164A
1212	EFD	O0C1212B1			PCB181121			PCB221321			O0B301902	4020	EC-IC	O0B402021			TVH61134A
		PCB1212B1			PCB181122			TCF2213B1			O0C301917	4022	EC	PCB4020N1	6410	EC-IC	O0C641001
1313	EP	OAC131316	1812	RM	O0C1812B1			O0C221620	3019	PC	O0B301903	4040	PQ	O0C404017	6527	EC	O0C652701
		OBC131314			TBA181201			PCB2311TA			O0B301903			PCB4040FA	7035	EC	O0B703501
		PCB1313B1			TCA1812C2			O0C2316B1			O0C301917	4119	EC	O0B411901			PCB703501
		SMB1313B1						PCB2318TA			PCB301911			OAC411919			PCH703501
1406	TC	TVB22066A									PCB301921			OCC411900	7228	EC	O0B722801
		TVH22064A									PCB3019TA			PCB411901	8020	EC	O0B8020B1
1407	TC	TVB22066A									TBP669000						
		TVH22064A									TCF2800B1						
											O0C3030B1						
											PCB3030B1						

Power Design

Ferrite is an ideal core material for transformers, inverters and inductors in the frequency range 20 kHz to 3 MHz, due to the combination of low core cost and low core losses. Ferrites may be used in the saturating mode for low power, low frequency operation (<50 watts and 10 kHz). Ferrite cores may also be used in flyback transformer designs, which offer low core cost, low circuit cost and high voltage capability. Powder cores (MPP, High Flux, Edge[®], Kool Mu[®], Kool Mu[®] MAX, Kool Mu[®] Hf, and XFlux[®]) offer soft saturation, higher B_{max} , and superior temperature stability and are often the best choice for minimum size and robust performance in power choke, inductor, and flyback applications.

CORE GEOMETRIES

POT CORES

Pot cores, when assembled, nearly surround the wound bobbin. This aids in shielding the coil from pickup of EMI from outside sources. The pot core dimensions follow IEC standards so that there is interchangeability between manufacturers. Both plain and printed circuit bobbins are available, as are mounting and assembly hardware.

ROUND SLAB, DOUBLE SLAB & RM CORES

Slab-sided solid center post cores resemble pot cores, but have a section cut off on either side of the skirt. The additional openings allow larger wires to be accommodated and assist in removing heat from the assembly. RM cores are also similar to pot cores, but are designed to minimize board space, providing at least a 40% savings in mounting area. Printed circuit or plain bobbins are available. One-piece clamps permit simple assembly. Low profile is possible. The solid center post generates less core loss and minimizes heat buildup.

PQ CORES

PQ cores are designed specifically for switched mode power supplies. One result is an optimized ratio of volume to winding area and surface area, meaning that maximum inductance and winding area are possible with a minimum core size. The cores provide maximum power output with minimum assembled transformer weight and volume, in addition to taking up a minimum amount of area on the printed circuit board.

Assembly with printed circuit bobbins and one piece clamps is simplified. PQs provide a more uniform cross-sectional area, so they tend to operate with less pronounced hot spots than most other cores.

EC, ETD AND EER CORES

These shapes combine the benefits of E cores and pot cores. Like E cores, they have a wide opening on each side. This provides ample space for the large wires used for low output voltage switched mode power supplies. It also increases the flow of air which keeps the assembly cooler. The center leg is round, like that of the pot core. One of the advantages of the round center leg is that the winding has a shorter path length around it (11% shorter) than the wire around a square center leg with an equal area. This reduces the losses of the windings by 11% and

enables the core to handle a higher output power. The round center leg eliminates the sharp bend in the wire that occurs with winding on a square center leg.

E, ER AND PLANAR E CORES

E cores offer the advantage of simple bobbin winding and ease of assembly. A wide variety of standard lamination-size, metric and DIN sizes are available. E cores are a low-cost choice in designs that do not require self-shielding. Planar cores are the best selection for low profile applications. Copper traces that are layered in the printed circuit board are the windings in most planar applications. This type of design provides superior thermal characteristics, economical assembly, low leakage inductance, and consistent performance.

EP CORES

EP cores are round center post cubical shapes which enclose the coil completely except for the printed circuit board terminals. The particular shape minimizes the effect of air gaps formed at mating surfaces in the magnetic path and provides a larger volume ratio to total space used. Shielding is excellent.

TOROIDS

Toroids are the least expensive ferrite shape. Available in a variety of sizes, outer diameters of 2.54 mm – 140 mm, toroids have good self-shielding properties. The fact that the core is a solid with no sections to assemble makes it a good choice if mechanical integrity is important in a high vibration environment. Toroid cores are available uncoated or with an epoxy, nylon or Parylene coating.

CORE MATERIALS

POWER

Magnetics R, P, F, T and L materials provide superior saturation, high temperature performance, low losses and product consistency.

T material is ideal for consistent performance over a wide temperature range. Applications for T include: Automotive, Electronic Lighting, Outdoor LCD Screens, Mobile Handheld Devices and AC adapters and chargers.

L material was formulated for high-frequency and high-temperature applications. L is designed for DC-DC converters, filters and power supplies that operate from 0.5 – 3.0 Mhz. Curie temperature is high for a ferrite material at 280°C.

R material is an economical, low-loss choice for a broad range of applications.

P material offers similar properties to R material, but is more readily available in some sizes.

F material is an established material with a relatively high permeability and 210°C Curie temperature.

Power Supplies, DC-DC Converters, Handheld Devices, High Power Control (gate drive) and EMI Filters are just a few of the applications that are typical for Magnetics ferrite power materials.

FILTER

Magnetics high permeability materials are engineered for optimum frequency and impedance performance in signal, choke and filter applications.

J and W materials offer high impedance for broadband transformers and are suitable for low-level power transformers.

J material is a medium perm, general-purpose material.

J's properties are well suited both for EMI/RFI filtering and broadband transformers.

W material has set the industry standard for high perm materials. In filter applications, W perm has 20-50% more impedance below 1 MHz than J perm.

M material is Magnetics' highest permeability material at 15,000 μ . Applications for M include: EMI/RFI suppression filters, common mode chokes, signal processing, and broadband transformers.

LINEAR FILTERS AND SENSORS

Magnetics **C**, **E** and **V materials** offer excellent properties for low-level signal applications. These materials set the standard for high quality factor, long-term stability and precise and adjustable inductance. Applications for these materials include high Q filters, wideband transformers, pulse transformers and RLC tuned circuits.

Inductor Design

Ferrite E cores and pot cores offer the advantages of decreased cost and low core losses at high frequencies. For switching regulators, power materials are recommended because of their temperature and DC bias characteristics. By adding air gaps to these ferrite shapes, the cores can be used efficiently while avoiding saturation.

These core selection procedures simplify the design of inductors for switching regulator applications. One can determine the smallest core size, assuming a winding factor of 50% and wire current carrying capacity of 500 circular mils per ampere.

Only two parameters of the design applications must be known:

- (a) Inductance required with DC bias
- (b) DC current

1. Compute the product of Ll^2 where:
 L = inductance required with DC bias (millihenries)
 I = maximum DC output current + 1/2 AC Ripple
2. Locate the Ll^2 value on the Ferrite Core Selector charts shown. Follow this coordinate up to the intersection with the first core size curve. Read the maximum nominal inductance, A_L , on the Y-axis. This represents the smallest core size and maximum A_L at which saturation will be avoided.
3. Any core size line that intersects the Ll^2 coordinate represents a workable core for the inductor if the core's A_L value is less than the maximum value obtained on the chart.
4. Required inductance L , core size, and core nominal inductance (A_L) are known. Calculate the number of turns using

$$N = 10^3 \sqrt{\frac{L}{A_L}}$$

where L is in millihenries.

5. Example: If $I_{MAX} = 8$ Amps; L , inductance required = 100 μ Henries
 $Ll^2 = (0.100 \text{ mH}) \times (8^2 \text{ Amps}) = 6.4$ millijoules
6. There are many ferrite cores available that will support the energy required. Any core size that the Ll^2 coordinate intersects can be used at the A_L value shown on the chart.
7. Some choices based upon an Ll^2 value of 6.4 millijoules are:
 Pot core 43622 $A_L = 400$ Double Slab 43622 $A_L = 250$
 PQ core 43220 $A_L = 300$ E core 44317 $A_L = 250$
8. For the following A_L values the number of turns required is:
 $A_L = 400$, $N = 16$ $A_L = 300$, $N = 19$ $A_L = 250$, $N = 20$
 Make sure the wire size chosen will support the current and fit into the core set.

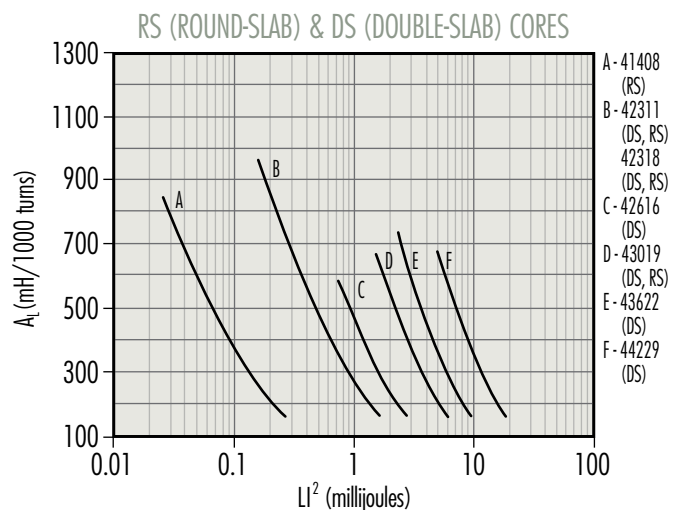
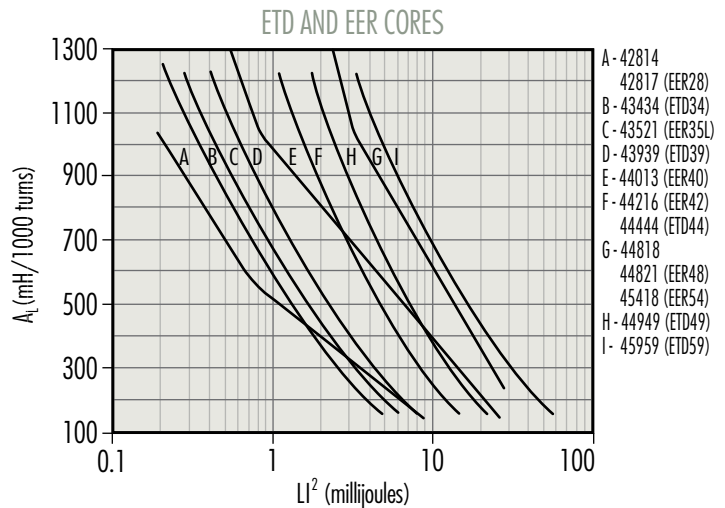
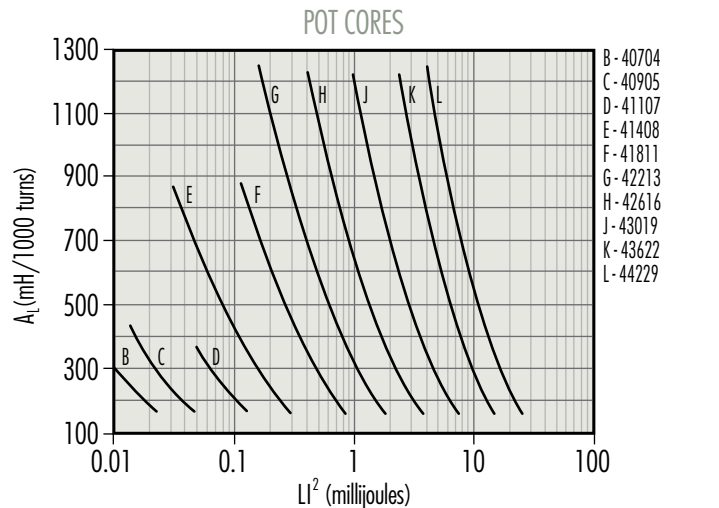

Inductor Design

RM AND EP CORES

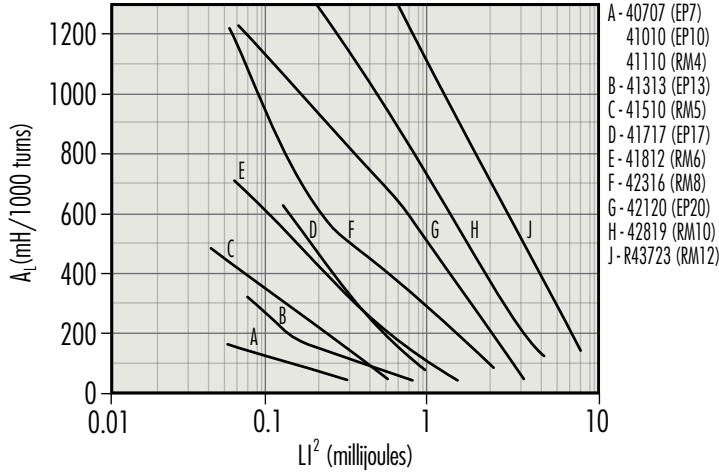

PQ CORES

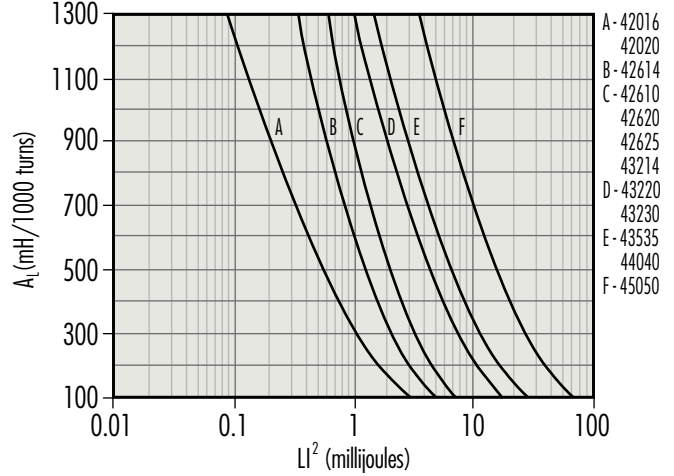

LAMINATION SIZE E CORES

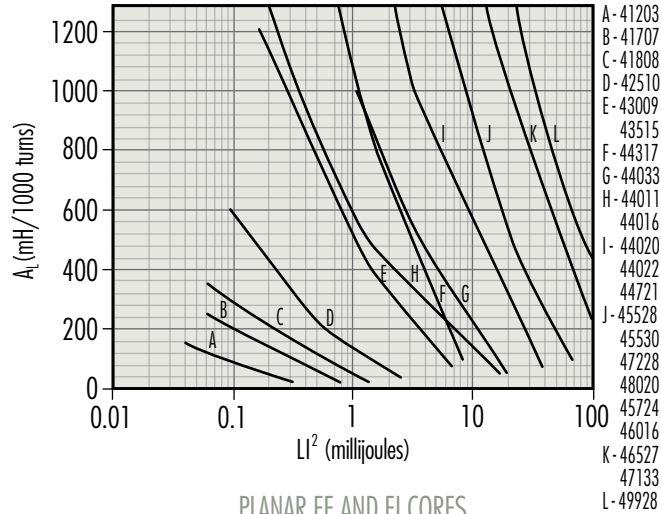

E CORES

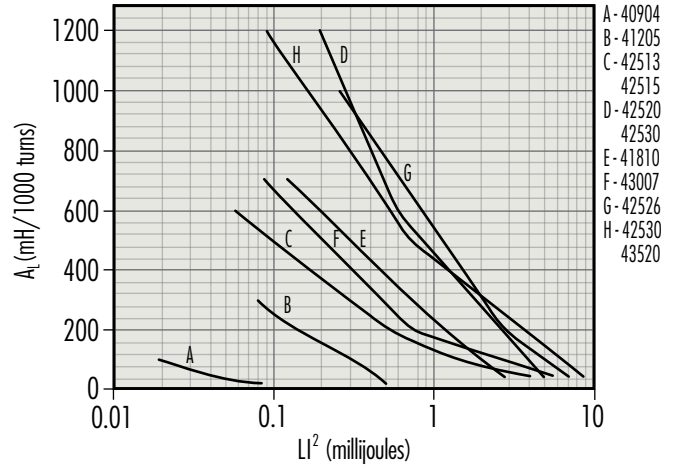

PLANAR EE AND EI CORES

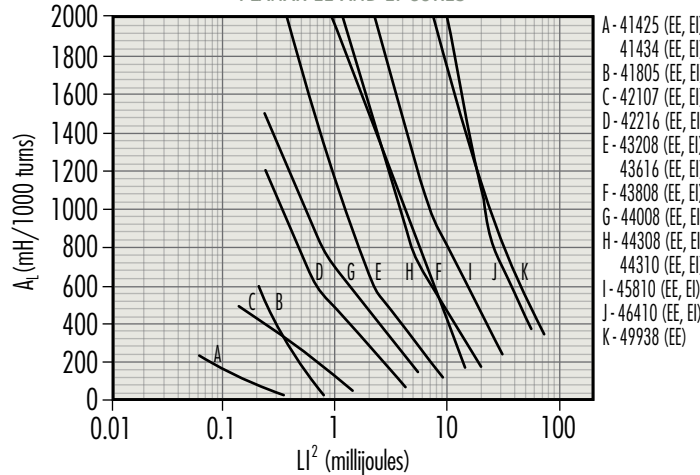

ER, EFD, AND EC CORES

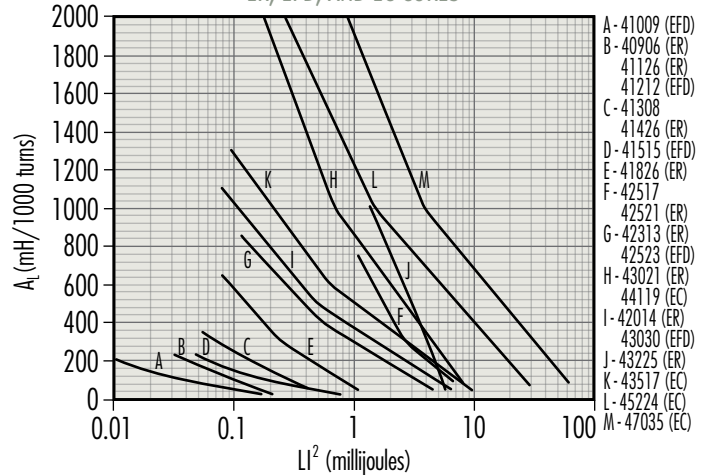

Inductor Design

DC BIAS DATA — FOR GAPPED APPLICATIONS

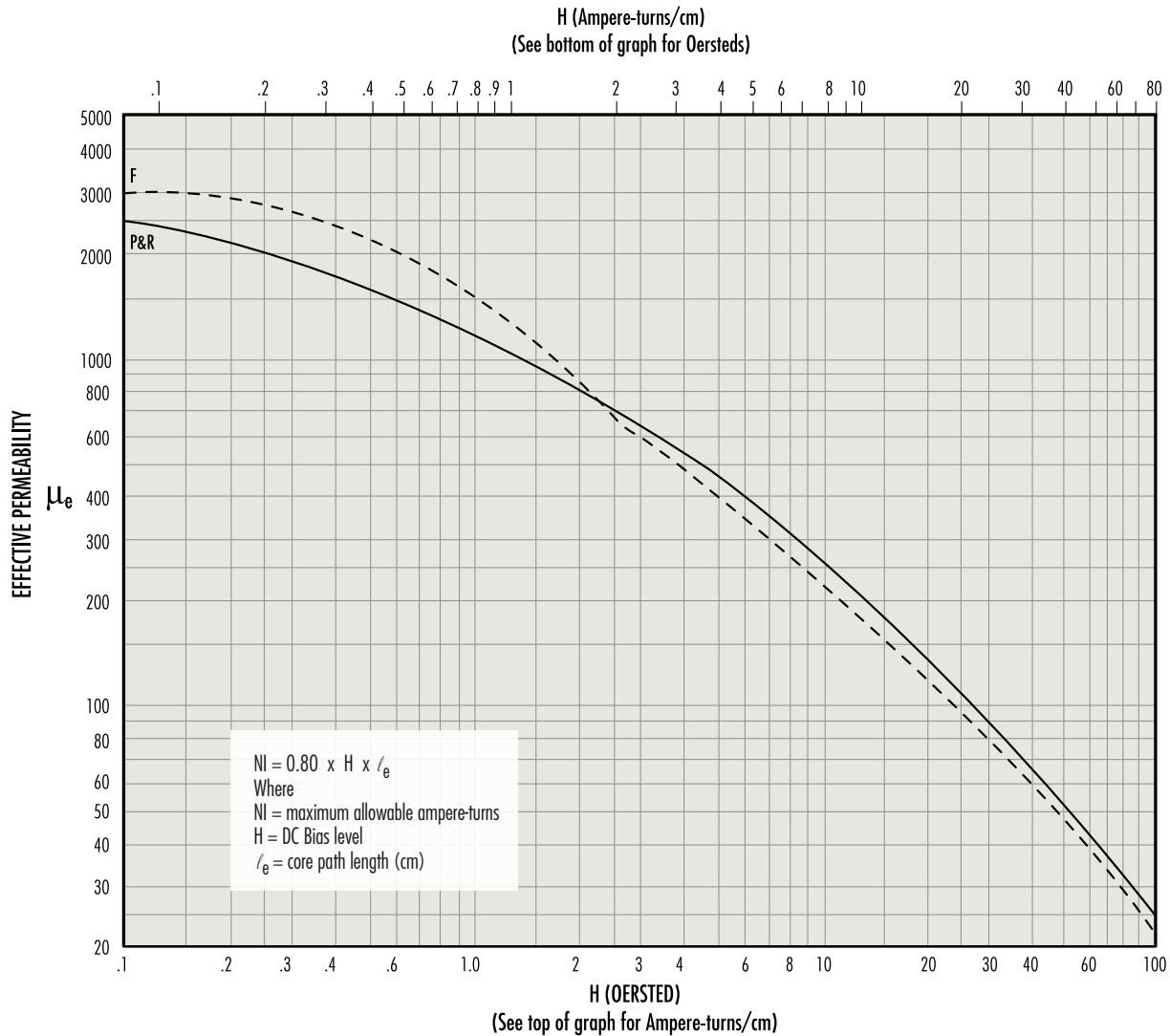

The above curves are limit curves, up to which *effective permeability* remains constant. They show the maximum allowable DC bias, in ampere-turns, without a reduction in inductance. Beyond this level (see insert), inductance drops rapidly.

Example: How many ampere-turns can be supported by an R42213A315 pot core without a reduction in inductance value?

$$l_e = 3.12 \text{ cm} \quad \mu_e = 125$$

Maximum allowable H = 25 Oersted (from the graph above)

NI (maximum) = $0.80 \times H \times l_e = 62.4$ ampere-turns
 or (Using top scale, maximum allowable H = 20 A-T/cm.)

$$\begin{aligned} \text{NI (maximum)} &= \text{A-T/cm} \times l_e \\ &= 20 \times 3.12 \\ &= 62.4 \text{ A-T} \end{aligned}$$

$$\mu_e = \frac{A_L \cdot l_e}{4 \pi A_e}$$

$$\frac{1}{\mu_e} = \frac{1}{\mu_i} + \frac{l_g}{l_e}$$

A_e = effective cross sectional area (cm^2)
 A_L = inductance/1,000 turns (mH)
 μ_i = initial permeability
 l_g = gap length (cm)

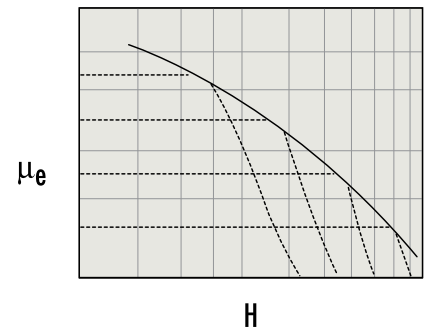

Inductance falls off rapidly above the limit curve. The dashed lines illustrate the μ_e curve for individual gapped core sets.

Transformer Design

Magnetics offers two methods to select a ferrite core for a power application.

CORE SELECTION BY POWER HANDLING CAPACITY

The Power Chart characterizes the power handling capacity of each ferrite core based upon the frequency of operation, the circuit topology, the flux level selected, and the amount of power required by the circuit. If these four specifics are known, the core can be selected from the Power Chart on page 68.

CORE SELECTION BY WaAc PRODUCT

The power handling capacity of a transformer core can also be determined by its WaAc product, where Wa is the available core window area, and Ac is the effective core cross-sectional area. Using the equation shown below, calculate the WaAc product and then use the Area Product Distribution (WaAc) Chart to select the appropriate core.

$$WaAc = \frac{P_o D_{cma}}{K_t B_{max} f}$$

WaAc = Product of window area and core area (cm⁴)

P_o = Power Out (watts)

D_{cma} = Current Density (cir. mils/amp) Current density can be selected depending upon the amount of heat rise allowed. 750 cir. mils/amp is conservative; 500 cir. mils is aggressive.

B_{max} = Flux Density (gauss) selected based upon frequency of operation. Above 20 kHz, core losses increase. To operate ferrite cores at higher frequencies, it is necessary to operate the core flux levels lower than ± 2 kG. The Flux Density vs. Frequency chart shows the reduction in flux levels required to maintain 100 mW/cm³ core losses at various frequencies, with a maximum temperature rise of 25°C for a typical power material, Magnetics P material.

A_c = Core area in cm²

V = Voltage

f = frequency (hertz)

I_p = Primary current

K_t = Topology constant

I_s = Secondary current

(for a space factor of 0.4)

N_p = Number of turns on the primary

N_s = Number of turns on the secondary

TOPOLOGY CONSTANTS K_t

Forward converter = 0.0005

Push-Pull = 0.001

Half-bridge = 0.0014

Full-bridge = 0.0014

Flyback = 0.00033 (single winding)

Flyback = 0.00025 (multiple winding)

For individual cores, WaAc is listed in this catalog under "Magnetic Data."

The WaAc formula was obtained from derivations in Chapter 7 of A. I. Pressman's book, "Switching Power Supply Design. Choice of B_{max} at various frequencies, D_{cma} and alternative transformer temperature rise calculations are also discussed in Chapter 7 of the Pressman book.

FLUX DENSITY VS. FREQUENCY P MATERIAL

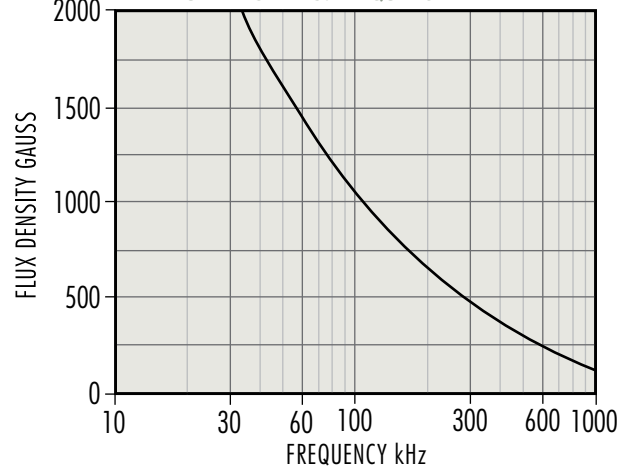

Once a core is chosen, the calculation of primary and secondary turns and wire size is readily accomplished.

$$N_p = \frac{V_p \times 10^8}{4BA_c f} \quad N_s = \frac{V_s}{V_p} N_p$$

$$I_p = \frac{P_{in}}{V_{in}} \quad I_s = \frac{P_{out}}{V_{out}}$$

$$KWA = N_p A_{wp} + N_s A_{ws}$$

Where

A_{wp} = primary wire area

A_{ws} = secondary wire area

Assume K = .4 for toroids; .6 for pot cores and E-I cores

Assume N_pA_{wp} = 1.1 N_sA_{ws} to allow for losses and feedback winding

$$\text{efficiency } e = \frac{P_{out}}{P_{in}} = \frac{P_{out}}{P_{out} + \text{wire losses} + \text{core losses}}$$

$$\text{Voltage Regulation (\%)} = \frac{V_{no\ load} - V_{full\ load}}{V_{full\ load}} \times 100$$

Typical Power Handling Chart

Power in Watts				Pot, RS, DS	E Cores	RM, PQ, EP	UU, UI, UR	ETD, EER, EC	EFD, Planar	Toroid
20 kHz	50 kHz	100 kHz	250 kHz							
2	3	4	7	41811 RS DS PC	41205 EE 41707 EE	41313 EP 41812 RM 41912 RM			42107 EE 41805 EE	40907 TC 41406 TC 41303 TC 41435 TC 41304 TC 41206 TC 41506 TC 41407 TC 41405 TC 41305 TC
5	8	11	21	41814 PC 42311 RS DS HS	41808 EE	41717 EP 42013 RM 42016 PQ 42610 PQ			42019 EFD 42216 EI 42214 EI 43208 EI	41306 TC 41607 TC 41450 TC 41410 TC 41605 TC 41610 TC 41606 TC
12	18	27	52		41810 EE 42510 EE	42316 RM				
13	20	29	56	42213 PC		42614 PQ				
15	22	32	62	42318 RS DS HS					42214 EE	
18	28	40	78			42020 PQ			42523 EFD	
19	30	42	83	42616 RS DS HS	42513 EE 42515 EI	42120 EP 43214 PQ	42515 UI		42216 EE 43618 EI 42217 EE 44008 EI	42106 TC 41809 TC
26	42	58	113						43208 EE	42206 TC
28	45	63	122		42520 EE				43030 EFD	
30	49	67	131	42616 RS PC		42620 PQ				42109 TC
33	53	74	144		42515 EE	42819 RM				42207 TC
40	61	90	175		42526 EE 43007 EE					42506 TC
42	70	94	183	43019 HS		42625 PQ			43618 EE	
48	75	108	210	42823 PC 43019 RS DS PC	43009 EE		42512 UU 42515 UU	42929 ETD	44008 EE	42507 TC
60	97	135	262		42530 EE 43515 EE	43220 PQ		43517 EC	43808 EI	42212 TC
70	110	157	306	43622 DS HS		43723 RM	42220 UU 42530 UU	42814 EER 42817 EER 43434 ETD		42508 TC 42908 TC 42712 TC
105	160	235	460	43622 RS	44011 EE 44317 EE				44308 EI 44310 EI	
120	195	270	525	43622 PC		43230 PQ			43808 EE	43806 TC
130	205	290	570		43520 EE	44230 RM		44119 EC	43809 EE	
150	240	337	656		44016 EE 44020 EI			43521 EER 43939 ETD	44308 EE	43113 TC 42915 TC
200	310	450	875						44310 EE	43610 TC

Typical Power Handling Chart

Power in Watts				Pot, RS, DS	E Cores	RM, PQ, EP	UU, UI, UR	ETD, EER, EC	EFD, Planar	Toroid
20 kHz	50 kHz	100 kHz	250 kHz							
220	350	495	962		44721 EE		44119 UR			
230	350	550	1073	44229 RS DS		43535 PQ	44121 UR	44013 EER		
260	400	585	1137							43813 TC
280	430	630	1225	44229 PC	44020 EE			44216 EER		
300	450	675	1312					44444 ETD 44818 EER 45224 EC	45810 EI	43615TC
340	550	765	1487		44033 EE		44125 UR			
360	580	810	1575		44022 EE	44040 PQ		45418 EER		43620 TC
410	650	922	1793		44033 EE 45724 EE		44130 UR	44821 EER 44949 ETD	46410 EI	44416 TC 44419 TC 43825 TC
550	800	1237	2406		46016 EE					44015 TC 44715 TC
650	1000	1462	2843			45050 PQ			45810 EE	
700	1100	1575	3062		45528 EE		45716 UR	45454 ETD	46410 EE	44920 TC 44916 TC
900	1500	2000	3900		45530 EE					44925 TC
1000	1600	2250	4375	43428 UG	47228 EE 46022 EE		45917 UR	45959 ETD 47035 EC		46013 TC 46113 TC
1600	2600	3700	7215				46420 UR			44932 TC 46019 TC
2000	3000	4500	8750		46527 EE 47133 EE 48020 EE					46325 TC 46326 TC 47313 TC
2800	4200	6500	12675				49316 UI 49316 UU		49938 EE	48613 TC 48626 TC 47325 TC 49715 TC 48619 TC 49718 TC 48625 TC
11700	19000	26500	51500		49928 EE		49330 UU 49332 UU 49920 UU 49925 UI 49925 UU			49725 TC 49740 TC

Ferrite Core selection listed by typical Power Handling Capabilities (Chart is for Power Ferrite Materials, F, P, R, L and T, Push-Pull Square wave operation)

Wattage values shown above are for push-pull converter design. De-rate by a factor of 3 or 4 for flyback. De-rate by a factor of 2 for feed-forward converter.
Example: For a feed-forward converter to be used at 300 watts select a core that is rated at 600 watts based on the converter topology.

Note: Assuming core loss to be approximately 100 mW/cm³, B Levels used in this chart are:

@ 20 kHz - 200 mT, 2000 gauss; @ 50 kHz - 130 mT, 1300 gauss; @ 100 kHz - 90 mT, 900 gauss; @ 250 kHz - 70 mT, 700 gauss

Area Product Distribution (WaAc) Chart

WaAc (cm ⁴)	RS, DS, HS	E	EC, EER, EFD, ETD	EP, RM	ER	Planar	Pot	PQ	TC	U, UR
<0.001									40200 TC 40301 TC 40502 TC	
0.001									40401 TC 40402 TC 40503 TC 40601 TC	
0.002		40904 EE					40704 UG			
0.003					40906 EE		40905 UG		40603 TC	
0.004			41009 EFD		41126 EE					
0.005				40707 EP						
0.006					41308 EI		41107 UG			
0.008						41434 EI			40705 TC	
0.01			41212 EFD	41010 EP 41110 RM	41308 EE 41426 EE	41425 EE	41109 UG		41003 TC	41106 UI
0.02	41408 RS DS HS	41203 EE	41515 EFD	41510 RM		41434 EE	41408 UG		41005 TC	41106 UU
0.03		41205 EE 41707 EE		41313 EP	41826 EE	42107 EI 41805 EI			40907 TC	
0.04						41805 EI			41303 TC 41435 TC	
0.05	41811 HS			41812 RM	42313 EE				41206 TC 41304 TC 41405 TC 41407 TC 41506 TC	
0.06				41717 EP 41912 RM		42107 EE	41410 UG		41305 TC	
0.07	41811 RS DS				42014 EI	42107 EE 41805 EE	41811 UG	42610 UG	41306 TC 41406 TC	
0.08	42311 DS HS	41808EE			42517EI				41450TC	
0.09			42019 EFD				41814 UG			
0.1	42311 RS	41810 EE			42014 EE	42216 EI			41605 TC	
0.2	42318 RS DS HS	42510 EE 42515 EI	42523 EFD	42013 RM 42120 EP 42316 RM	42517 EE 43021 EI	42214 EI	42213 UG	42016 UG 42020 UG 42614 UG	41606 TC 41607 TC 41410 TC 41610 TC	
0.3	42616 RS DS HS	42513 EE	43030 EFD		42521 EE 43225 EE	43618 EI 42216 EE 42214 EE		43214 UG	41809 TC 42106 TC	42515 UI
0.4		42526 EE		42819 RM		42217 EE 43208 EI 44008 EI	42616 UG	42620 UG	42109 TC 42206 TC	
0.5		42520 EE 43007 EE	42814 EER		43021 EE				42207 TC	
0.6	43019 DS HS	42515 EE 43009 EE				43618 EE	42823 UG	42625 UG		42220 UU 42515 UU
0.7	43019 RS	42530 EE	42929 EFD 42817 EER			43208 EE	43019 UG		42507 TC	
0.8			43517 EC			44008 EE		43220 UG	42506 TC 42212 TC	42512 UU
0.9						43808 EI			42508 TC	

Area Product Distribution (WaAc) Chart

WaAc (cm ²)	RS, DS, HS	E	EC, EER, EFD, ETD	EP, RM	ER	Planar	Pot	PQ	TC	U, UR
<1	43622 RS DS HS	43515 EE 44011 EE 44020 EI	43434 ETD	43723 RM		44308 EI			42712 TC 42908 TC	42530 UU
2		44016 EE 44317 EE 43520 EE	43521 EER 43939 ETD 44013 EER 44119 EC	44230 RM		44310 EI 43808 EE	43622 UG	43230 UG	42915 TC 43113 TC 43806 TC	
3	44229 RS DS	44721 EE	44216 EER 44818 EER			43809 EE 44308 EE		43535 UG	43610 TC 43813 TC	44119 UR 44121 UR
4		44020 EE 44022 EE	44444 ETD 44821 EER 45224 EC 45418 EER			44310 EE	44229 UG		43615 TC	44125 UR
5						45810 EI		44040 UG	43620 TC 44416 TC	44130 UR
6		44033 EE 46016 EE	44949 ETD			46410 EI			44419 TC	
7		45724 EE							43825 TC 44015 TC	
8						45810 EE		45050 UG	44715 TC	
9			45454 ETD						44920 TC	45716 UR
10		45528 EE								
11						46410 EE			44916 TC	
12		45530 EE								
13			47035 EC						44925 TC	
14			45959 ETD							45917 UR
15		47228 EE								
16									46013 TC 46113 TC	
21		46022 EE							44932 TC	
22										46420 UU
23		47133 EE					43428 UG			
24		46527 EE								
25									46019 TC 47313 TC	
34		48020 EE							46325 TC 46326 TC	
46									48613 TC	49316 UI
51						49938 EE			47325 TC	
61										49925 UI
70									48619 TC	
91		49928 EE							48625 TC 48626 TC 49715 TC	49316 UU
106									49718 TC	
121										49925 UU
171									49725 TC	
286										49920 UU
372									49740 TC	

Other Products from Magnetics



POWDER CORES

Powder cores are excellent as low loss inductors for switched-mode power supplies, switching regulators and noise filters. Most core types can be shipped immediately from stock.

Magnetics **Kool M μ** [®] powder cores exhibit low losses at elevated frequencies. Kool M μ is available in 7 permeabilities and a variety of core types for maximum flexibility. Toroids offer compact size and self-shielding. E cores, U cores, EQ cores, and LP cores afford lower cost of winding, use of foil windings or helical windings, and ease of fixturing. For very high current applications, very large cores and structures are available including toroids up to 165 mm, large E cores, U cores, stacked shapes, and blocks.

Magnetics **Kool M μ** [®] **MAX** powder cores offer 50% better DC bias performance than standard Kool M μ material. Available in 7 permeabilities from 14 μ to 90 μ including toroids, blocks, U cores and E cores.

Magnetics **Kool M μ** [®] **Hf** powder cores are the best option for achieving superior efficiency in medium and high current power inductors and are available in 26 μ , 40 μ and 60 μ .

Magnetics **XFlux**[®] powder cores are made from 6.5% silicon iron powder for very high saturation flux density, comparable with High Flux. XFlux is available in 7 permeabilities from 19 μ to 125 μ and multiple shapes including toroids, E cores, block cores, EQ cores, LP cores, and EER cores.

Magnetics **High Flux** powder cores exhibit very high resistance to saturation at high current. High Flux is available in 7 permeabilities from 14 μ to 160 μ and over 30 sizes. Shapes include toroids, EQ cores, LP cores, and EER cores.

Magnetics **Edge**[®] powder cores are the best option for achieving smallest package size in high frequency, current-limited power inductors and are available in 5 permeabilities from 19 μ to 125 μ .

Magnetics **Molypermalloy (MPP)** powder cores have extremely low core losses, highest Q, and best temperature stability compared with other materials. Standard cores include either temperature stabilized (guaranteed flat as wide as -65°C to 125°C for stable operation) or standard stabilization. MPP toroidal cores are available in 10 permeabilities from 14 μ to 550 μ and sizes identical to High Flux.



TAPE WOUND CORES

Strip wound cores are made from high permeability magnetic strip alloys of nickel-iron (80% or 50% nickel), and silicon-iron. The alloys are known as Orthonol[®], Permalloy 80, 48 Alloy and Magnesil[®]. Tape Wound Cores are produced as small as 0.438" OD in hundreds of sizes. For a wide range of frequency applications, materials are produced in thicknesses from 1/2 mil (0.013 mm) through 4 mils (0.102 mm). Cases are robust nylon and aluminum boxes, rated for 200°C continuous operation and 2,000 minimum voltage breakdown.

Tape wound cores are useful for both power and signal circuits in harsh environmental conditions where robust component operation is essential to achieve high reliability.

BOBBIN CORES

Bobbin cores are miniature tape cores made from ultrathin (0.000125" to 0.001" thick) strip material wound on nonmagnetic stainless steel bobbins. Bobbin cores are generally manufactured from Permalloy 80 and Orthonol[®]. Covered with protective caps and then epoxy coated, bobbin cores can be made as small as 0.05" ID and with strip widths down to 0.032". Bobbin cores can switch from positive to negative saturation in a few microseconds or less, with very high peak impedance (relative permeability) while not saturated, making them ideal for analog logic elements, magnetometers, and pulse transformers.

Bobbin cores are also useful for analog counters, timers, magnetic sensors, and other analog circuits in harsh environmental conditions where robust and reliable operation is essential.

NANOCRYSTALLINE CORES

Nanocrystalline cores are made from amorphous metal which is annealed to create a uniform nanocrystalline microstructure. Sizes include toroids and split cores from 5 mm to 145 mm, and durable cases are available in polyester (<130°C) and rynite polyester (<155°C). Nanocrystalline cores are a choice solution for applications such as common mode chokes and current transformers as they exhibit high permeability, low power loss, and high saturation.

AMORPHOUS CORES

Amorphous cores are made from metallic glass materials with an amorphous atomic structure, which creates higher resistivity than nanocrystalline cores. Amorphous cores offer excellent frequency response and efficiency, and they are a choice solution for high frequency, low loss applications. Magnetics offers amorphous cut cores (C shape) from 51 mm to 131 mm, with toroids and split cores available upon request.

Website

For updates and more in-depth product information, visit mag-inc.com

- Design Equations
- Area Product Distribution (WaAc) and Power Charts
- Product Datasheets
- Product Catalogs
- Design Software
- Distributor Stock Check
- Part Number Search
- Cross Reference Tool

